

TO-92 Plastic-Encapsulate Transistors

2SB562 TRANSISTOR (PNP)

FEATURES

- Low frequency power amplifier
- Complementary pair with 2SD468

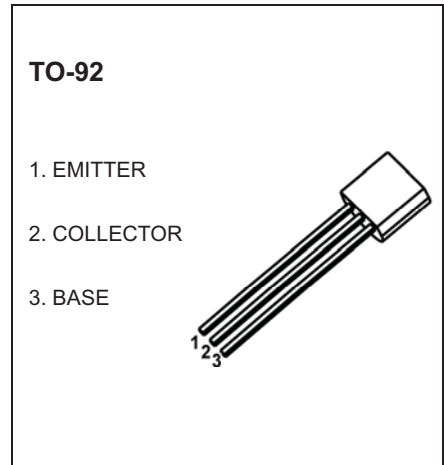

MARKING

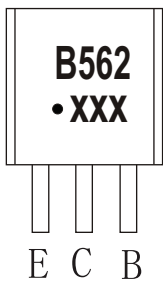

B562=Device code
Solid dot=Green molding compound device,
if none,the normal device
XXX=Code

Equivalent Circuit

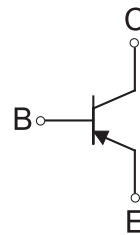

ORDERING INFORMATION

| Part Number | Package | Packing Method | Pack Quantity |
|-------------|---------|----------------|---------------|
| 2SB562 | TO-92 | Bulk | 1000pcs/Bag |
| 2SB562-TA | TO-92 | Tape | 2000pcs/Box |

MAXIMUM RATINGS (T_a=25°C unless otherwise noted)

| Symbol | Parameter | Value | Unit |
|------------------|---|-----------|-------|
| V _{CB0} | Collector-Base Voltage | -25 | V |
| V _{CE0} | Collector-Emitter Voltage | -20 | V |
| V _{EB0} | Emitter-Base Voltage | -5 | V |
| I _c | Collector Current -Continuous | -1 | A |
| P _D | Collector Power Dissipation | 625 | mW |
| R _{θJA} | Thermal Resistance from Junction to Ambient | 200 | °C /W |
| T _j | Junction Temperature | 150 | °C |
| T _{stg} | Storage Temperature | -55 ~+150 | °C |

ELECTRICAL CHARACTERISTICS

$T_a=25^\circ\text{C}$ unless otherwise specified

| Parameter | Symbol | Test conditions | Min | Typ | Max | Unit |
|--------------------------------------|---------------|--|-----|-----|------|---------------|
| Collector-base breakdown voltage | $V_{(BR)CBO}$ | $I_C=-10\mu\text{A}, I_E=0$ | -25 | | | V |
| Collector-emitter breakdown voltage | $V_{(BR)CEO}$ | $I_C=-1\text{mA}, I_B=0$ | -20 | | | V |
| Emitter-base breakdown voltage | $V_{(BR)EBO}$ | $I_E=-10\mu\text{A}, I_C=0$ | -5 | | | V |
| Collector cut-off current | I_{CBO} | $V_{CB}=-20\text{V}, I_E=0$ | | | -1 | μA |
| Emitter cut-off current | I_{EBO} | $V_{EB}=-4\text{V}, I_C=0$ | | | -1 | μA |
| DC current gain | h_{FE} | $V_{CE}=-2\text{V}, I_C=-0.5\text{A}$ | 85 | | 240 | |
| Collector-emitter saturation voltage | $V_{CE(sat)}$ | $I_C=-0.8\text{A}, I_B=-0.08\text{A}$ | | | -0.5 | V |
| Base-emitter voltage | V_{BE} | $V_{CE}=-2\text{V}, I_C=-0.5\text{A}$ | | | -1 | V |
| Transition frequency | f_T | $V_{CE}=-2\text{V}, I_C=-0.5\text{A}$ | | 350 | | MHz |
| Collector output capacitance | C_{ob} | $V_{CB}=-10\text{V}, I_E=0, f=1\text{MHz}$ | | 38 | | pF |

CLASSIFICATION OF h_{FE}

| Rank | B | C |
|-------|--------|---------|
| Range | 85-170 | 120-240 |

Typical Characteristics

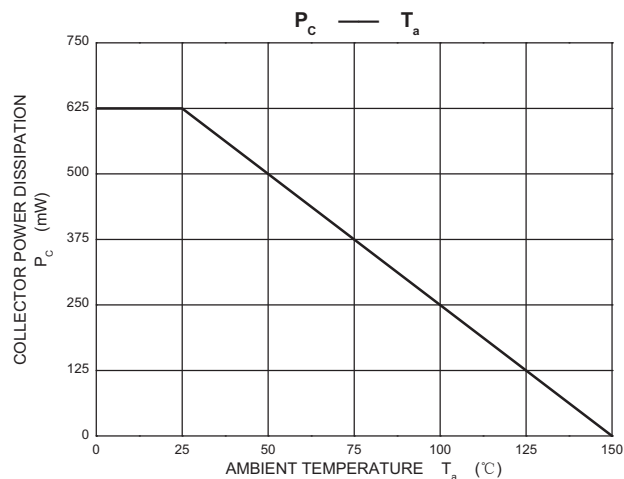
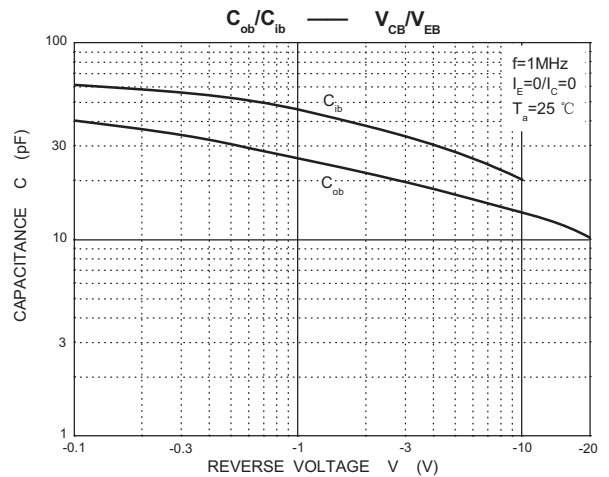
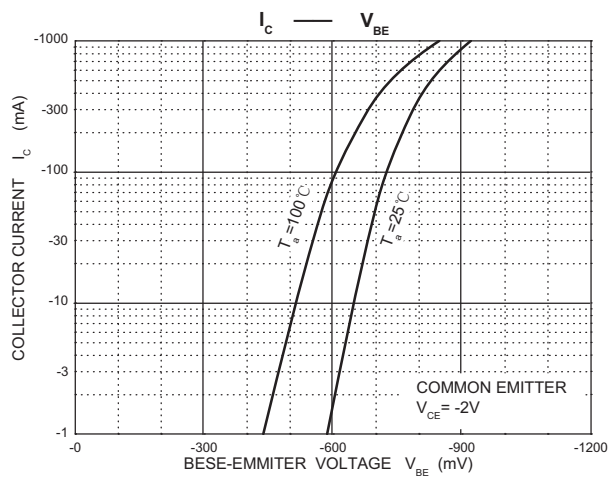
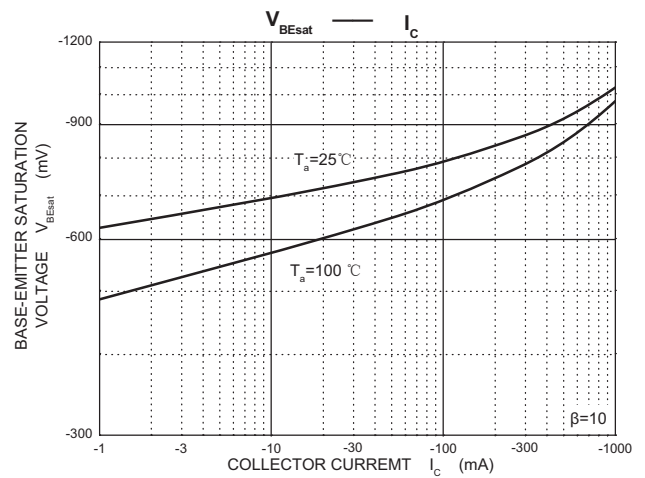
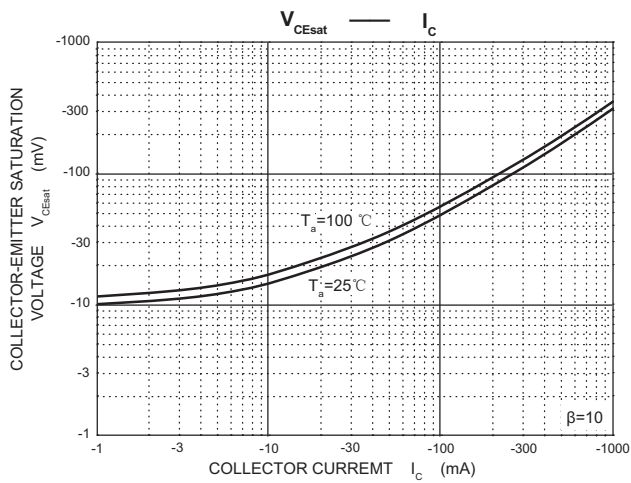
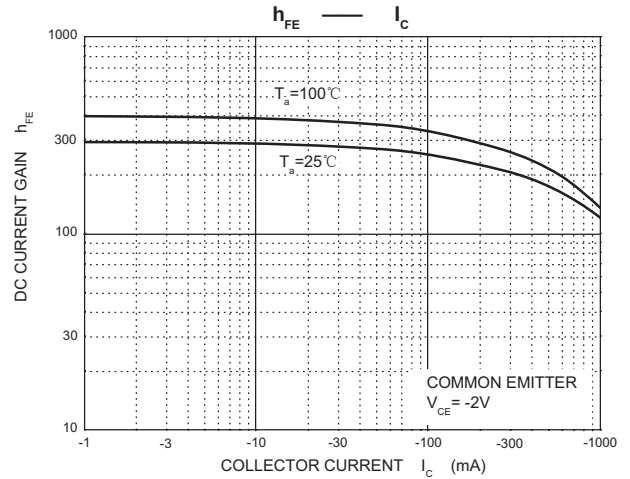
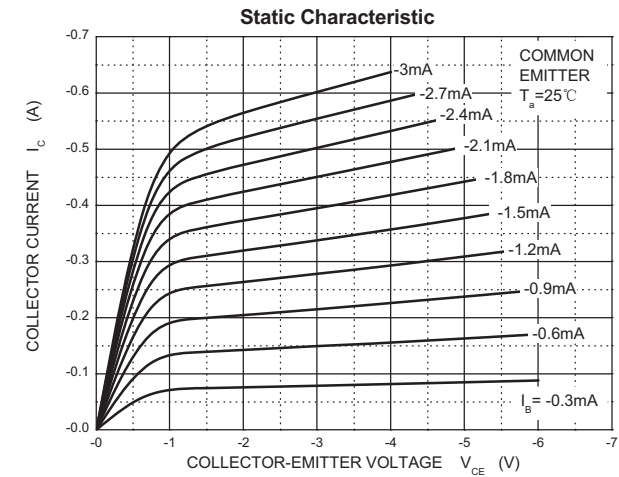

TO-92 Package Outline Dimensions

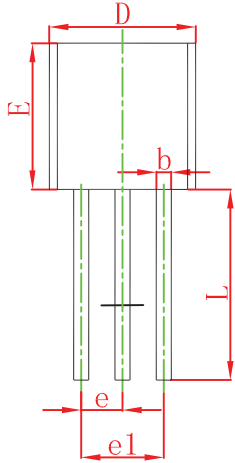
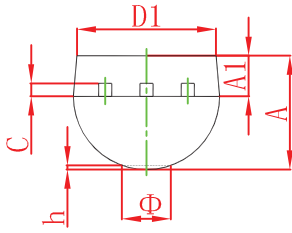

| Symbol | Dimensions In Millimeters | | Dimensions In Inches | |
|--------|---------------------------|--------|----------------------|-------|
| | Min | Max | Min | Max |
| A | 3.300 | 3.700 | 0.130 | 0.146 |
| A1 | 1.100 | 1.400 | 0.043 | 0.055 |
| b | 0.380 | 0.550 | 0.015 | 0.022 |
| c | 0.360 | 0.510 | 0.014 | 0.020 |
| D | 4.300 | 4.700 | 0.169 | 0.185 |
| D1 | 3.430 | | 0.135 | |
| E | 4.300 | 4.700 | 0.169 | 0.185 |
| e | 1.270 TYP | | 0.050 TYP | |
| e1 | 2.440 | 2.640 | 0.096 | 0.104 |
| L | 14.100 | 14.500 | 0.555 | 0.571 |
| Φ | | 1.600 | | 0.063 |
| h | 0.000 | 0.380 | 0.000 | 0.015 |

TO-92 Suggested Pad Layout

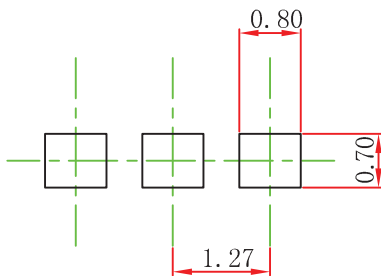

Note:

1. Controlling dimension: in millimeters.
2. General tolerance: $\pm 0.05\text{mm}$.
3. The pad layout is for reference purposes only.

NOTICE

JSCJ reserves the right to make modifications, enhancements, improvements, corrections or other changes without further notice to any product herein. JSCJ does not assume any liability arising out of the application or use of any product described herein.

TO-92 Tape and Reel

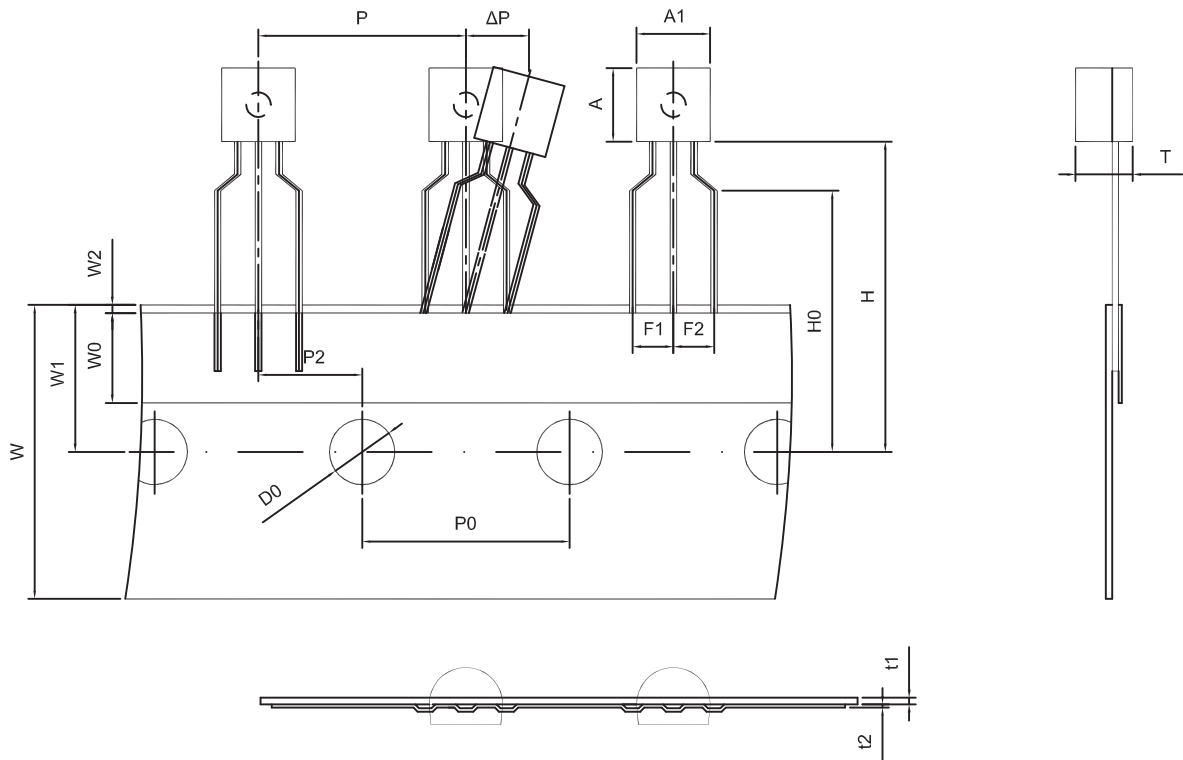

| Dimensions are in millimeter | | | | | | | | |
|------------------------------|-----|----------|------|------|------|-----|-----|------|
| A1 | A | T | P | P0 | P2 | F1 | F2 | W |
| 4.5 | 4.5 | 3.5 | 12.7 | 12.7 | 6.35 | 2.5 | 2.5 | 18.0 |
| W0 | W1 | W2 | H | H0 | D0 | t1 | t2 | ΔP |
| 6.0 | 9.0 | 1.0 MAX. | 19.0 | 16.0 | 4.0 | 0.4 | 0.2 | 0 |

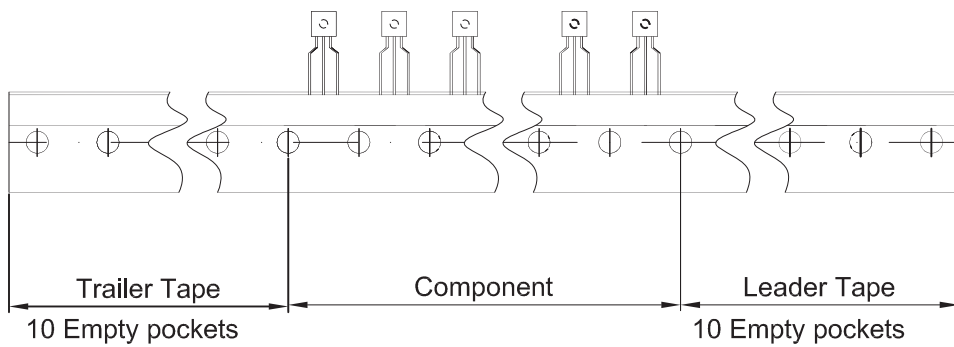

| Package | Box | Box Size(mm) | Carton | Carton Size(mm) |
|---------|----------|--------------|------------|-----------------|
| TO-92 | 2000 pcs | 333×162×43 | 20,000 pcs | 350×340×250 |