

## TO-92 Plastic-Encapsulate Transistors

### MPS2222A TRANSISTOR (NPN )

#### FEATURE

- Complementary NPN Type available (MPS2907A)

#### TO-92

1. EMITTER
2. BASE
3. COLLECTOR

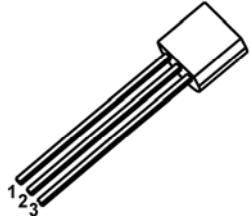

#### MARKING

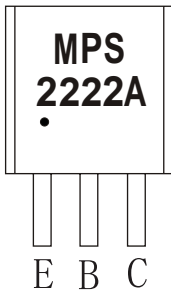

MPS2222A=Device code  
Solid dot=Green molding compound device,  
if none,the normal device

#### Equivalent Circuit

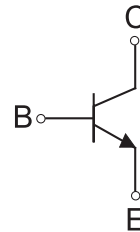

#### ORDERING INFORMATION

Part Number	Package	Packing Method	Pack Quantity
MPS2222A	TO-92	Bulk	1000pcs/Bag
MPS2222A-TA	TO-92	Tape	2000pcs/Box

#### MAXIMUM RATINGS (T<sub>a</sub>=25°C unless otherwise noted)

Symbol	Parameter	Value	Unit
V <sub>CBO</sub>	Collector-Base Voltage	75	V
V <sub>CEO</sub>	Collector-Emitter Voltage	40	V
V <sub>EBO</sub>	Emitter-Base Voltage	6	V
I <sub>C</sub>	Collector Current -Continuous	0.6	A
P <sub>D</sub>	Collector Power Dissipation	625	mW
R <sub>θJA</sub>	Thermal Resistance from Junction to Ambient	200	°C /W
T <sub>J</sub> ,T <sub>stg</sub>	Operation Junction and Storage Temperature Range	-55~+150	°C

# ELECTRICAL CHARACTERISTICS

$T_a=25^\circ\text{C}$  unless otherwise specified

Parameter	Symbol	Test conditions	Min	Max	Unit
Collector-base breakdown voltage	$V_{(BR)CBO}$	$I_C=10\mu\text{A}, I_E=0$	75		V
Collector-emitter breakdown voltage	$V_{(BR)CEO}$	$I_C=10\text{mA}, I_B=0$	40		V
Emitter-base breakdown voltage	$V_{(BR)EBO}$	$I_E=10\mu\text{A}, I_C=0$	6		V
Collector cut-off current	$I_{CBO}$	$V_{CB}=60\text{V}, I_E=0$		10	nA
Collector cut-off current	$I_{CEX}$	$V_{CE}=60\text{V}, V_{EB(Off)}=3\text{V}$		10	nA
Emitter cut-off current	$I_{EBO}$	$V_{EB}=3\text{V}, I_C=0$		100	nA
DC current gain	$h_{FE(1)}$	$V_{CE}=10\text{V}, I_C=150\text{mA}$	100	300	
	$h_{FE(2)}$	$V_{CE}=10\text{V}, I_C=0.1\text{mA}$	40		
	$h_{FE(3)}^*$	$V_{CE}=10\text{V}, I_C=500\text{mA}$	42		
Collector-emitter saturation voltage	$V_{CE(sat)(1)}^*$	$I_C=500\text{mA}, I_B=50\text{mA}$		0.6	V
	$V_{CE(sat)(2)}^*$	$I_C=150\text{mA}, I_B=15\text{mA}$		0.3	V
Base-emitter saturation voltage	$V_{BE(sat)}^*$	$I_C=500\text{mA}, I_B=50\text{mA}$		1.2	V
Delay time	$t_d$	$V_{CC}=30\text{V}, V_{EB(Off)}=-0.5\text{V},$		10	nS
Rise time	$t_r$	$I_C=150\text{mA}, I_{B1}=15\text{mA}$		25	nS
Storage time	$t_s$	$V_{CC}=30\text{V}, I_C=150\text{mA}, I_{B1}=I_{B2}=15\text{mA}$		225	nS
Fall time	$t_f$			60	nS
Transition frequency	$f_T$	$V_{CE}=20\text{V}, I_C=20\text{mA}, f=100\text{MHz}$	300		MHz

\* pulse test

## CLASSIFICATION OF $h_{FE(1)}$

Rank	L	H
Range	100-200	200-300

# Typical Characteristics

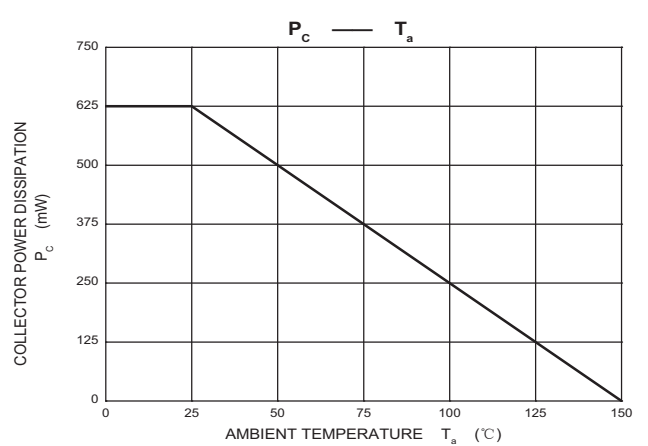
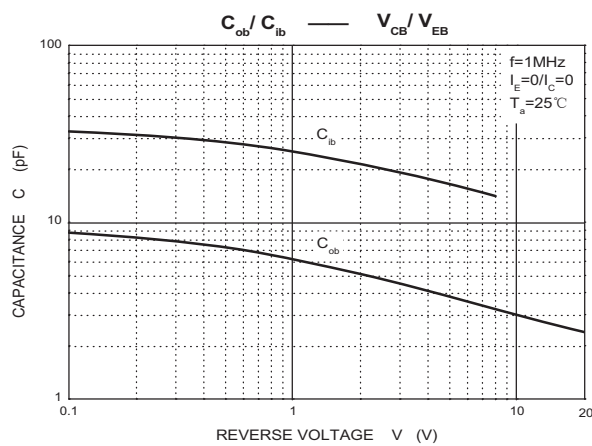
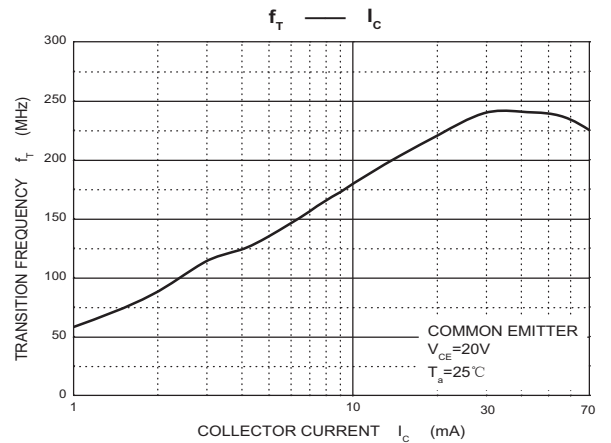
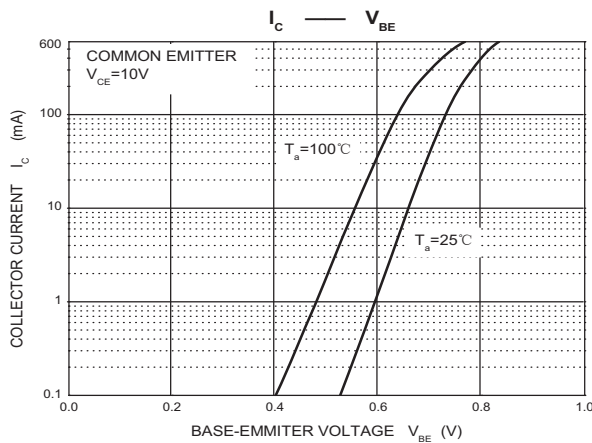
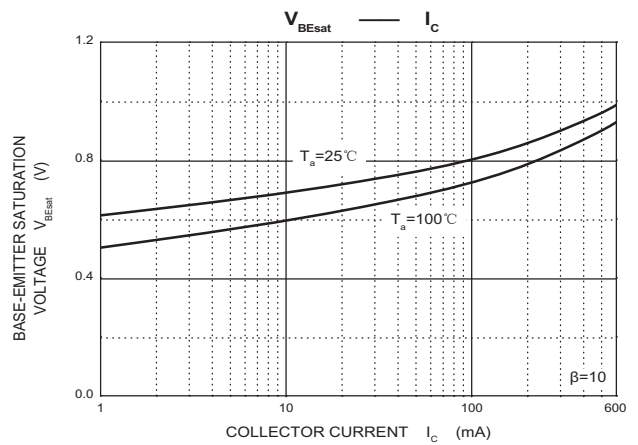
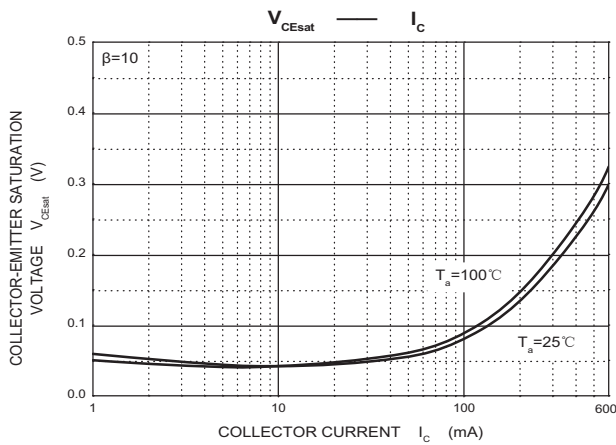
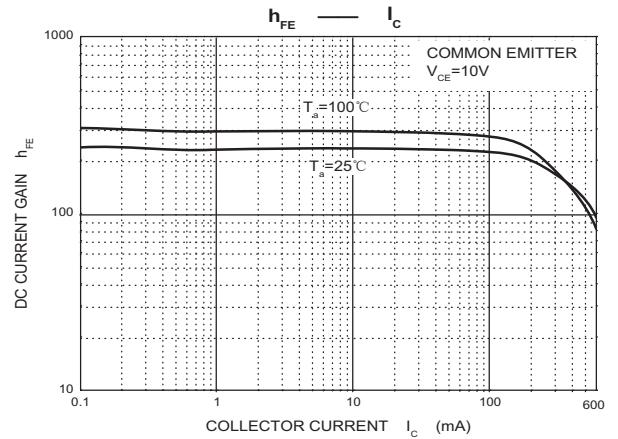
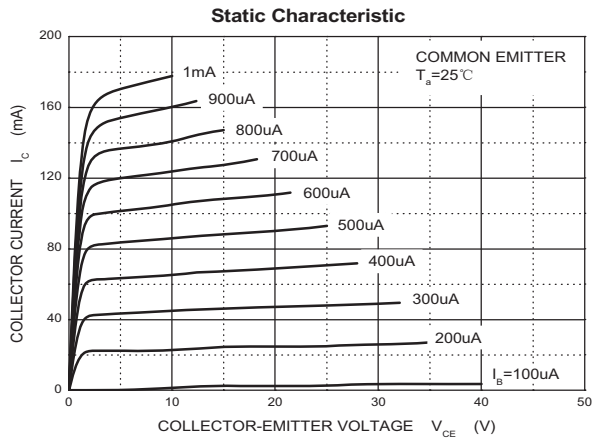

## TO-92 Package Outline Dimensions



Symbol	Dimensions In Millimeters		Dimensions In Inches	
	Min	Max	Min	Max
A	3.300	3.700	0.130	0.146
A1	1.100	1.400	0.043	0.055
b	0.380	0.550	0.015	0.022
c	0.360	0.510	0.014	0.020
D	4.300	4.700	0.169	0.185
D1	3.430		0.135	
E	4.300	4.700	0.169	0.185
e	1.270 TYP		0.050 TYP	
e1	2.440	2.640	0.096	0.104
L	14.100	14.500	0.555	0.571
Φ		1.600		0.063
h	0.000	0.380	0.000	0.015

## TO-92 Suggested Pad Layout



### Note:

1. Controlling dimension: in millimeters.
2. General tolerance:  $\pm 0.05\text{mm}$ .
3. The pad layout is for reference purposes only.

### NOTICE

JSCJ reserves the right to make modifications, enhancements, improvements, corrections or other changes without further notice to any product herein. JSCJ does not assume any liability arising out of the application or use of any product described herein.

# TO-92 Tape and Reel

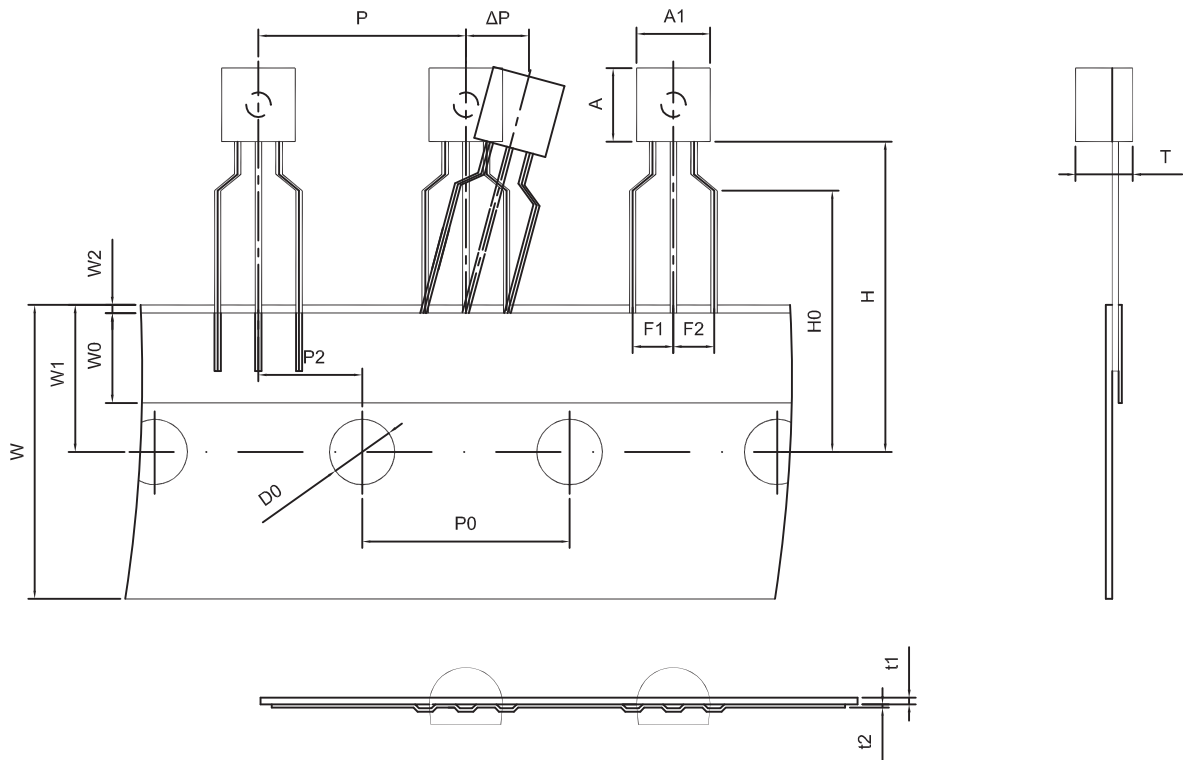

Dimensions are in millimeter

A1	A	T	P	P0	P2	F1	F2	W
4.5	4.5	3.5	12.7	12.7	6.35	2.5	2.5	18.0
W0	W1	W2	H	H0	D0	t1	t2	$\Delta P$
6.0	9.0	1.0 MAX.	19.0	16.0	4.0	0.4	0.2	0

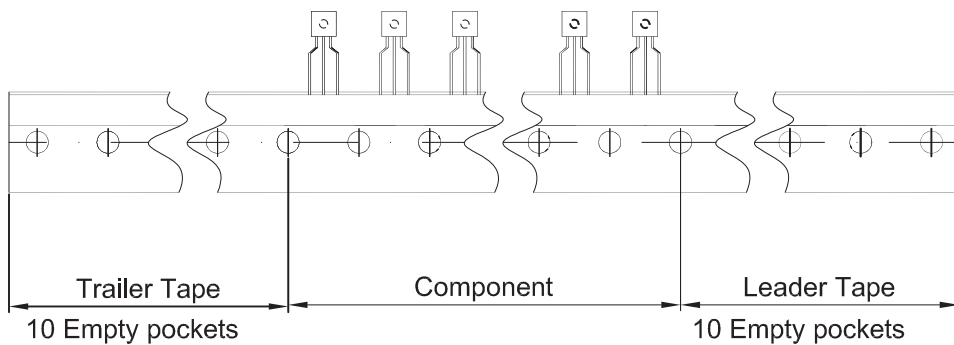

Package	Box	Box Size(mm)	Carton	Carton Size(mm)
TO-92	2000 pcs	333×162×43	20,000 pcs	350×340×250