

SOD-323 Plastic-Encapsulate Diodes

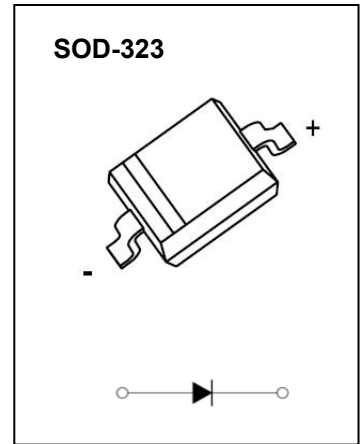

BAV19WS~BAV21WS SWITCHING DIODE

FEATURES

- Low Reverse Current
- Surface Mount Package Ideally Suited for Automatic Insertion
- Fast Switching Speed
- For General Purpose Switching Applications

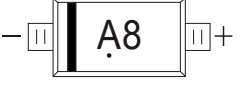
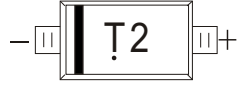
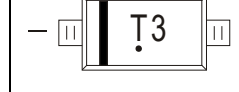

MARKING:

BAV19WS A8	BAV20WS T2	BAV21WS T3
		
		

The marking bar indicates the cathode
Solid dot = Green molding compound device,
if none, the normal device.

MAXIMUM RATINGS ($T_a=25^{\circ}\text{C}$ unless otherwise noted)

Symbol	Parameter	Value			Unit
		BAV19WS	BAV20WS	BAV21WS	
V_{RM}	Non-Repetitive Peak Reverse Voltage	120	200	250	V
V_{RRM}	Peak Repetitive Reverse Voltage	100	150	200	V
V_{RWM}	Working Peak Reverse Voltage				
$V_{R(RMS)}$	RMS Reverse Voltage	71	106	141	V
I_O	Average Rectified Output Current	200			mA
I_{FSM}	Non-repetitive Peak Forward Surge Current @ $t=8.3\text{ms}$	2.0			A
I_{FRM}	Repetitive Peak Forward Surge Current	625			mA
P_D	Power Dissipation	250			mW
$R_{\theta JA}$	Thermal Resistance from Junction to Ambient	500			$^{\circ}\text{C}/\text{W}$
T_J, T_{stg}	Operation Junction and Storage Temperature Range	-55~+150			$^{\circ}\text{C}$

ELECTRICAL CHARACTERISTICS($T_a=25^{\circ}\text{C}$ unless otherwise specified)

Parameter	Symbol	Test conditions	Min	Typ	Max	Unit
Reverse current	I_R	$V_R=100\text{V}$ BAV19WS			0.1	μA
		$V_R=150\text{V}$ BAV20WS			0.1	
		$V_R=200\text{V}$ BAV21WS			0.1	
Forward voltage	V_F	$I_F=100\text{mA}$			1	V
		$I_F=200\text{mA}$			1.25	
Total capacitance	C_{tot}	$V_R=0\text{V}, f=1\text{MHz}$			5	pF
Reverse recovery time	t_{rr}	$I_F=I_R=30\text{mA}, I_{rr}=0.1*I_R, R_L=100\Omega$			50	ns

BAV19WS Typical Characteristics

Forward Characteristics

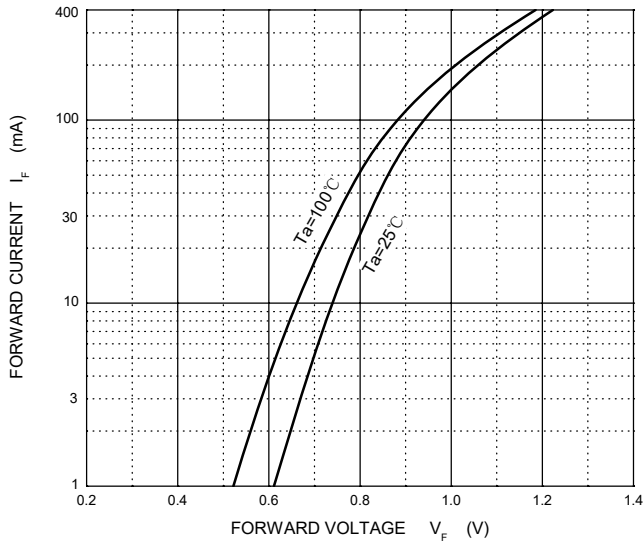

Reverse Characteristics

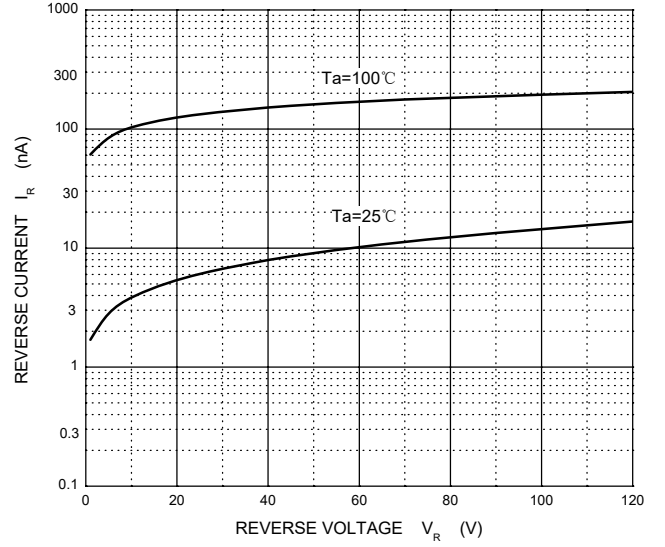

Capacitance Characteristics

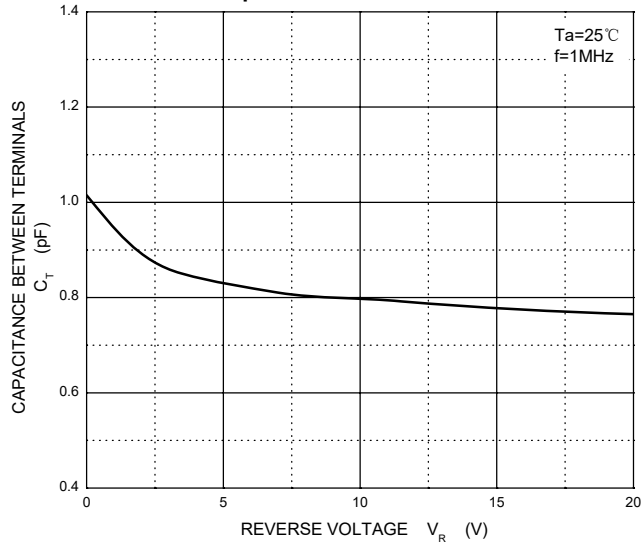

Power Derating Curve

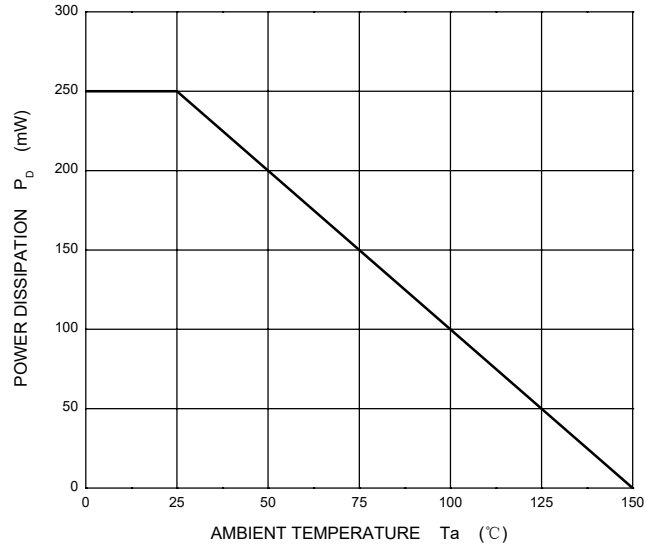

SOD-323 Package Outline Dimensions

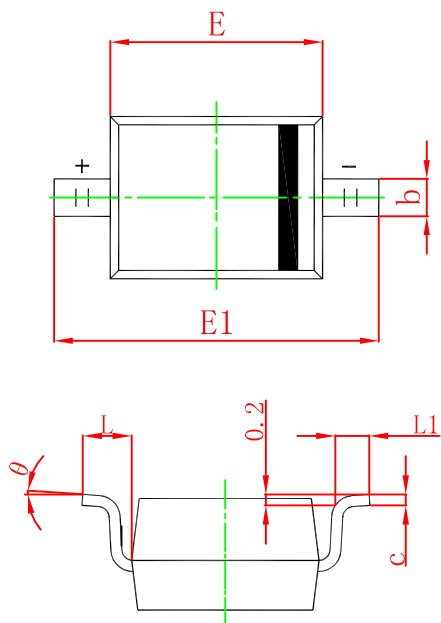

Symbol	Dimensions In Millimeters		Dimensions In Inches	
	Min	Max	Min	Max
A		1.100		0.043
A1	0.000	0.100	0.000	0.004
A2	0.800	1.000	0.031	0.039
b	0.250	0.350	0.010	0.014
c	0.080	0.150	0.003	0.006
D	1.200	1.400	0.047	0.055
E	1.600	1.800	0.063	0.071
E1	2.500	2.750	0.098	0.108
L	0.475 REF		0.019 REF	
L1	0.250	0.400	0.010	0.016
θ	0°		8°	

SOD-323 Suggested Pad Layout

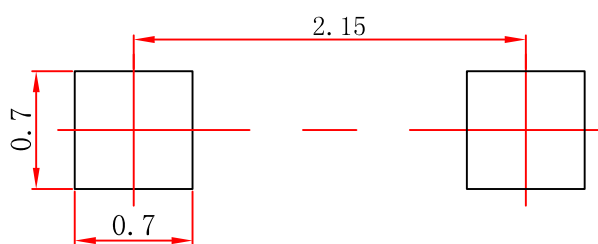

Note:

1. Controlling dimension: in millimeters.
2. General tolerance: ± 0.05mm.
3. The pad layout is for reference purposes only.

NOTICE

JSCJ reserves the right to make modifications, enhancements, improvements, corrections or other changes without further notice to any product herein. JSCJ does not assume any liability arising out of the application or use of any product described herein.

SOD-323 Tape and Reel

SOD-323 Embossed Carrier Tape



Packaging Description:

SOD-323 parts are shipped in tape. The carrier tape is made from a dissipative (carbon filled) polycarbonate resin. The cover tape is a multilayer film (Heat Activated Adhesive in nature) primarily composed of polyester film, adhesive layer, sealant, and anti-static sprayed agent. These reeled parts in standard option are shipped with 3,000 units per 7" or 17.8cm diameter reel. The reels are clear in color and is made of polystyrene plastic (anti-static coated).

Dimensions are in millimeter										
Pkg type	A	B	C	d	E	F	P0	P	P1	W
SOD-323	1.48	3.3	1.25	Ø1.50	1.75	3.50	4.00	4.00	2.00	8.00

SOD-323 Tape Leader and Trailer

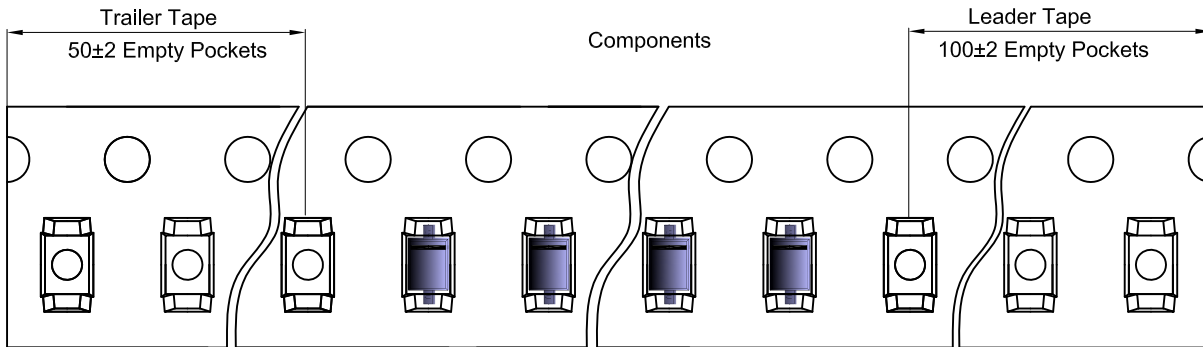

SOD-323 Reel

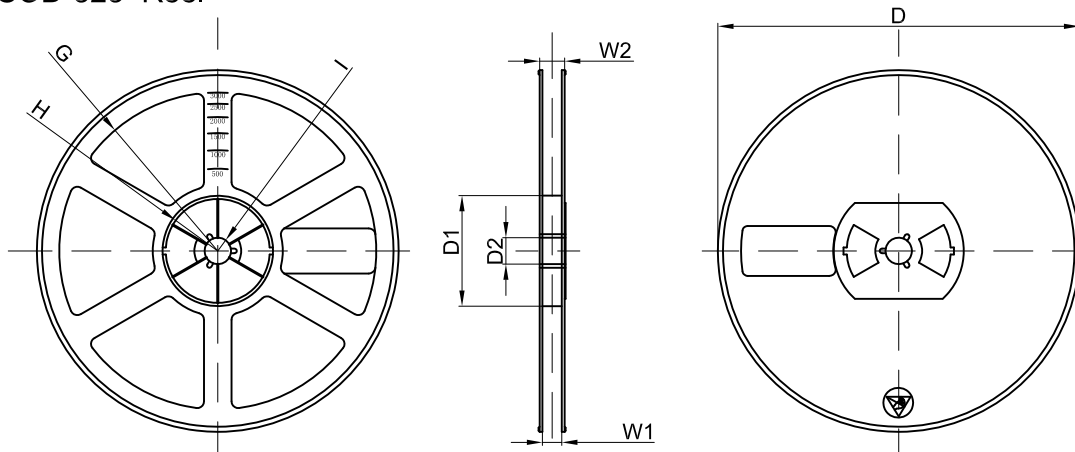

Dimensions are in millimeter								
Reel Option	D	D1	D2	G	H	I	W1	W2
7" Dia	Ø178.00	54.40	13.00	R78.00	R25.60	R6.50	9.50	12.30

REEL	Reel Size	Box	Box Size(mm)	Carton	Carton Size(mm)	G.W.(kg)
3000 pcs	7 inch	45,000 pcs	203×203×195	180,000 pcs	438×438×220	