

TO-92 Plastic-Encapsulate Transistors

2SB1116 / 2SB1116A TRANSISTOR (PNP)

FEATURES

- High Collector Power Dissipation .
- Complementary to 2SD1616/2SD1616A

TO-92

1. EMITTER
2. COLLECTOR
3. BASE

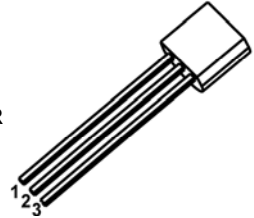

MARKING

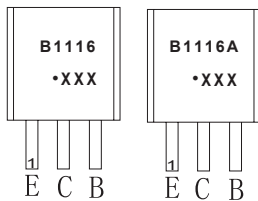

B1116,B1116A=Device code
 Solid dot=Green molding compound device,
 if none,the normal device
 XXX=Code

Equivalent Circuit

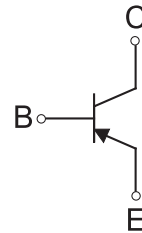

ORDERING INFORMATION

Part Number	Package	Packing Method	Pack Quantity
2SB1116	TO-92	Bulk	1000pcs/Bag
2SB1116-TA	TO-92	Tape	2000pcs/Box
2SB1116A	TO-92	Bulk	1000pcs/Bag
2SB1116A-TA	TO-92	Tape	2000pcs/Box

MAXIMUM RATINGS (T_a=25°C unless otherwise noted)

Symbol	Parameter	Value	Unit
V _{CBO}	Collector-Base Voltage	2SB1116	-60
		2SB1116A	-80
V _{CEO}	Collector-Emitter Voltage	2SB1116	-50
		2SB1116A	-60
V _{EBO}	Emitter-Base Voltage	-6	V
I _C	Collector Current -Continuous	-1	A
P _C	Collector Power Dissipation	0.75	W
T _J	Junction Temperature	150	°C
T _{stg}	Storage Temperature	-55-150	°C

ELECTRICAL CHARACTERISTICS

$T_a=25^\circ\text{C}$ unless otherwise specified

Parameter	Symbol	Test conditions	Min	Typ	Max	Unit
Collector-base breakdown voltage	$V_{(BR)CBO}$	$I_C=-100\mu\text{A}, I_E=0$	2SB1116 -60 2SB1116A -80			V
Collector-emitter breakdown voltage	$V_{(BR)CEO}$	$I_C=-1\text{mA}, I_B=0$	2SB1116 -50 2SB1116A -60			V
Emitter-base breakdown voltage	$V_{(BR)EBO}$	$I_E=-100\mu\text{A}, I_C=0$	-6			V
Collector cut-off current	I_{CBO}	$V_{CB}=-60\text{V}, I_E=0$	2SB1116		-0.1	μA
		$V_{CB}=-60\text{V}, I_E=0$	2SB1116A			
Emitter cut-off current	I_{EBO}	$V_{EB}=-6\text{V}, I_C=0$			-0.1	μA
DC current gain	$h_{FE(1)}$	$V_{CE}=-2\text{V}, I_C=-0.1\text{A}$	135		600	
	$h_{FE(2)}$	$V_{CE}=-2\text{V}, I_C=-1\text{A}$	81			
Collector-emitter saturation voltage	$V_{CE(sat)}$	$I_C=-1\text{A}, I_B=-50\text{mA}$			-0.3	V
Base-emitter saturation voltage	$V_{BE(sat)}$	$I_C=-1\text{A}, I_B=-50\text{mA}$			-1.2	V
Base-emitter voltage	V_{BE}	$V_{CE}=-2\text{V}, I_C=-0.05\text{A}$	-0.6		-0.7	V
Transition frequency	f_T	$V_{CE}=-2\text{V}, I_C=-0.1\text{A}$	70			MHz
Collector output capacitance	C_{ob}	$V_{CB}=-10\text{V}, I_E=0, f=1\text{MHz}$		25		pF
Turn-on time	t_{on}	$V_{CC}=-10\text{V}, I_C=-0.1\text{A}, I_{B1}=-I_{B2}=-0.01\text{A}, V_{BE(Off)}=2\text{to}3\text{V}$		0.07		us
Storage time	t_s			0.7		us
Fall time	t_f			0.07		us

CLASSIFICATION OF $h_{FE(1)}$

Rank	L	K	U
Range	135-270	200-400	300-600

Typical Characteristics

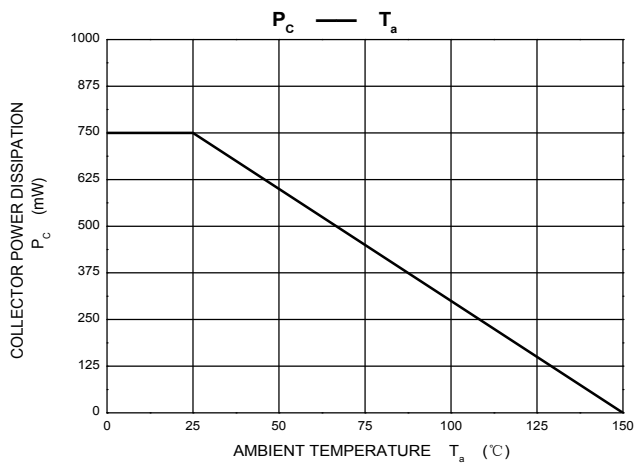
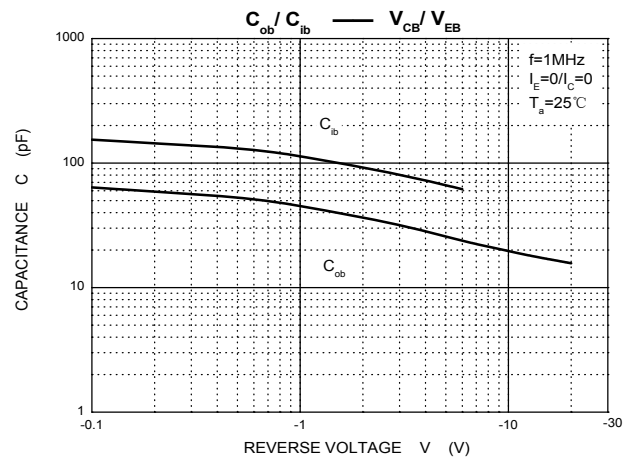
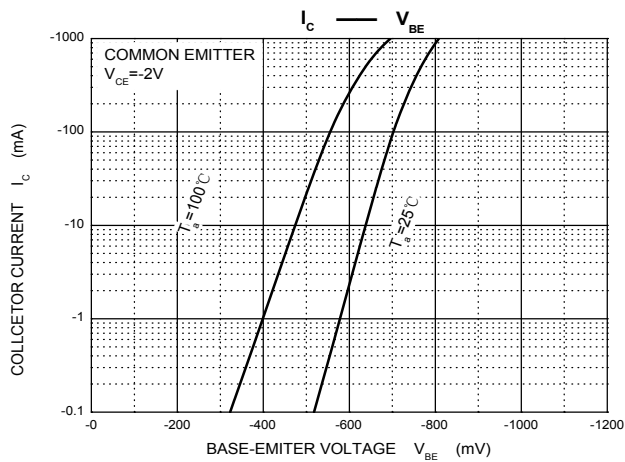
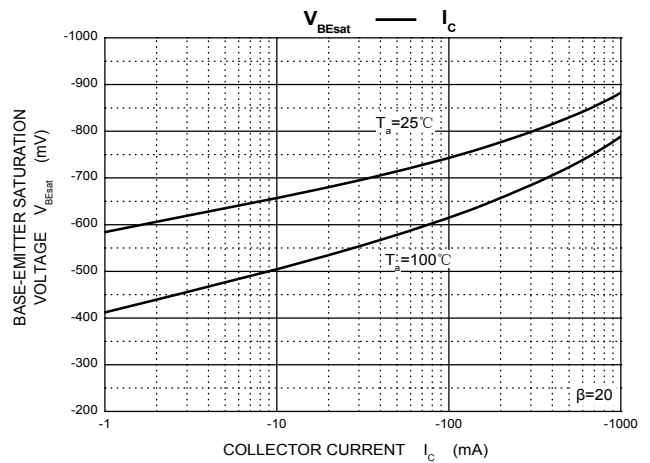
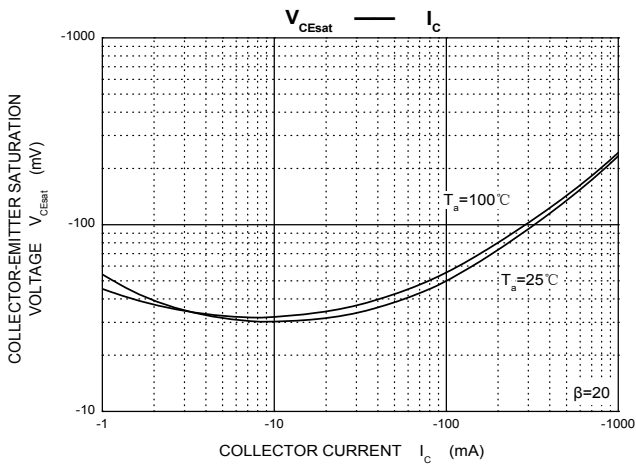
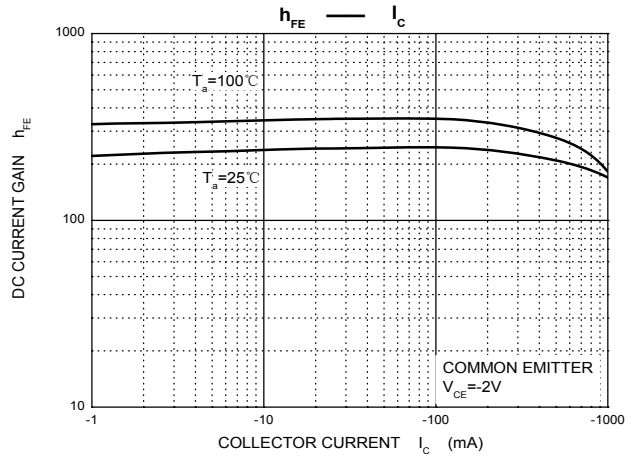
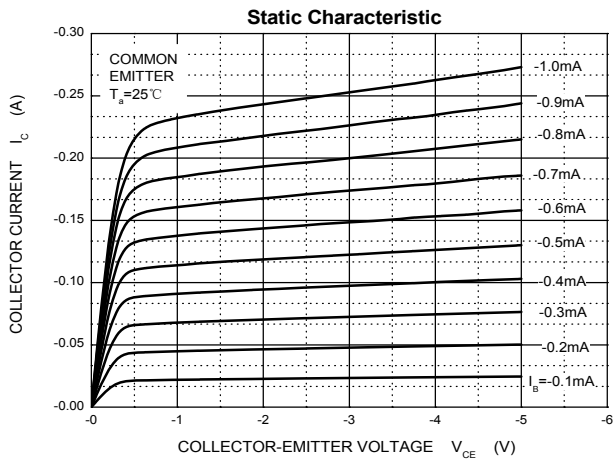

TO-92 Package Outline Dimensions



Symbol	Dimensions In Millimeters		Dimensions In Inches	
	Min	Max	Min	Max
A	3.300	3.700	0.130	0.146
A1	1.100	1.400	0.043	0.055
b	0.380	0.550	0.015	0.022
c	0.360	0.510	0.014	0.020
D	4.300	4.700	0.169	0.185
D1	3.430		0.135	
E	4.300	4.700	0.169	0.185
e	1.270 TYP		0.050 TYP	
e1	2.440	2.640	0.096	0.104
L	14.100	14.500	0.555	0.571
Φ		1.600		0.063
h	0.000	0.380	0.000	0.015

TO-92 Suggested Pad Layout



Note:

1. Controlling dimension: in millimeters.
2. General tolerance: $\pm 0.05\text{mm}$.
3. The pad layout is for reference purposes only.

NOTICE

JSCJ reserves the right to make modifications, enhancements, improvements, corrections or other changes without further notice to any product herein. JSCJ does not assume any liability arising out of the application or use of any product described herein.

TO-92 Tape and Reel

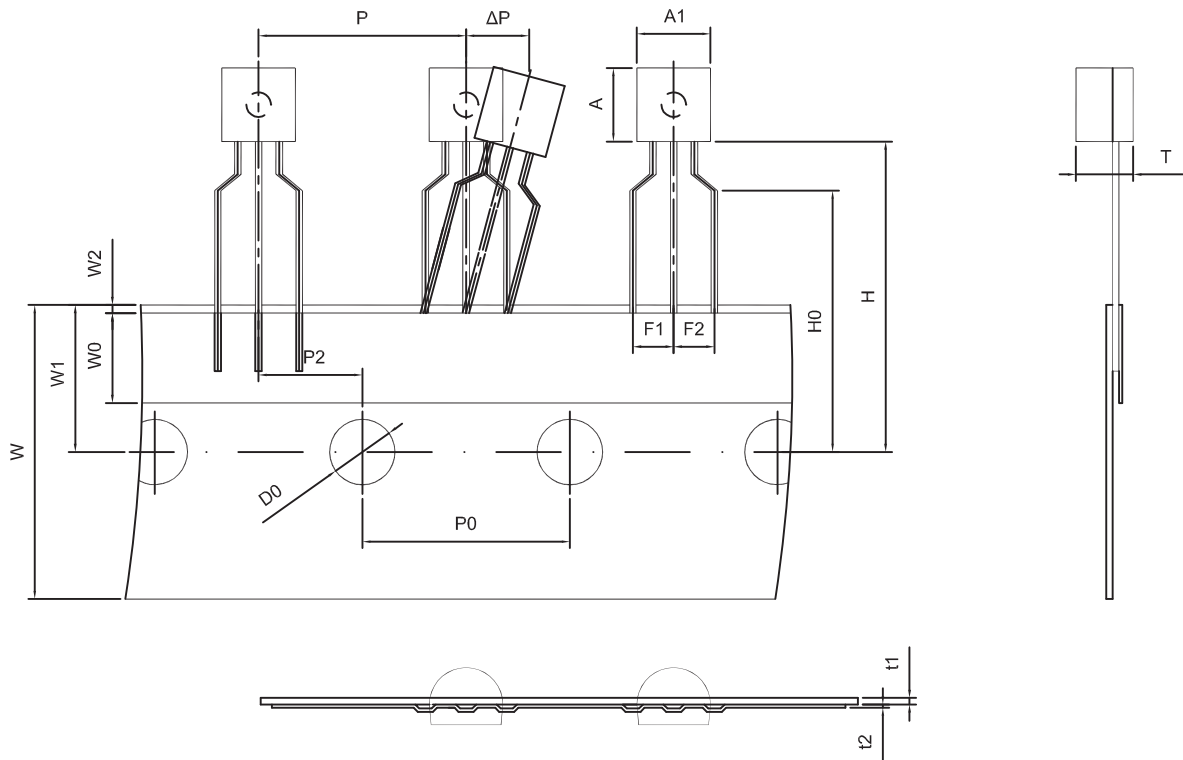

Dimensions are in millimeter								
A1	A	T	P	P0	P2	F1	F2	W
4.5	4.5	3.5	12.7	12.7	6.35	2.5	2.5	18.0
W0	W1	W2	H	H0	D0	t1	t2	ΔP
6.0	9.0	1.0 MAX.	19.0	16.0	4.0	0.4	0.2	0

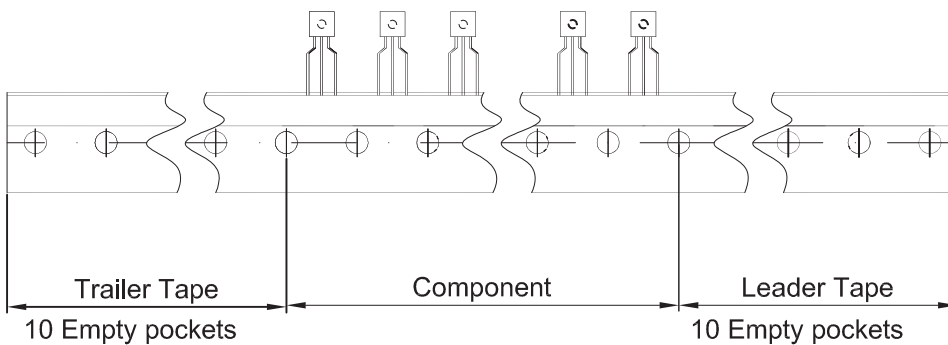

Package	Box	Box Size(mm)	Carton	Carton Size(mm)
TO-92	2000 pcs	333×162×43	20,000 pcs	350×340×250