

TO-92MOD Plastic-Encapsulate Transistors

2SB647/2SB647A TRANSISTOR (PNP)

FEATURES

- Low Frequency Power Amplifier
- Complementary Pair with 2SD667/A

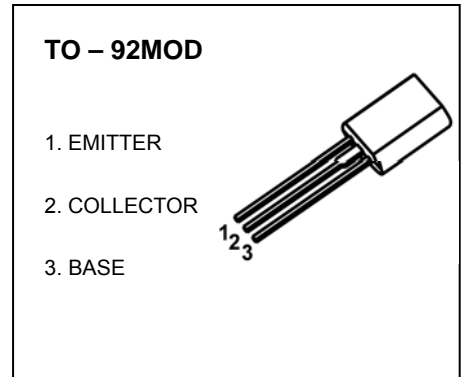

MARKING

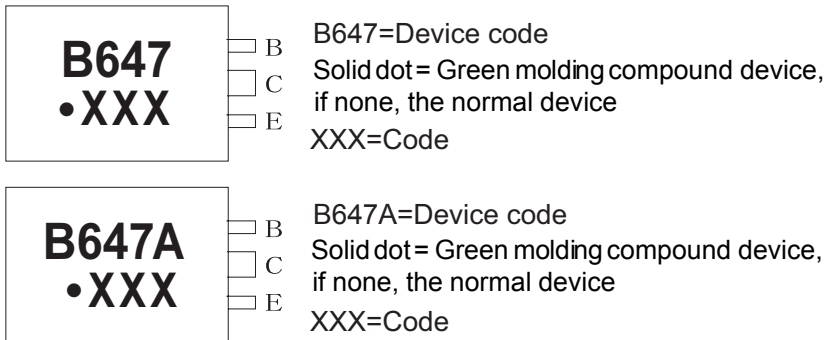

Equivalent Circuit

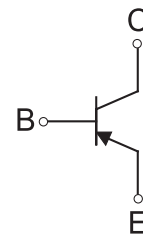

ORDERING INFORMATION

Part Number	Package	Packing Method	Pack Quantity
2SB647	TO-92MOD	Bulk	500pcs/Bag
2SB647-TA	TO-92MOD	Tape	2000pcs/Box
2SB647A	TO-92MOD	Bulk	500pcs/Bag
2SB647A-TA	TO-92MOD	Tape	2000pcs/Box

MAXIMUM RATINGS (T_a=25°C unless otherwise noted)

Symbol	Parameter	Value	Unit
V _{CB0}	Collector-Base Voltage	-120	V
V _{CE0}	Collector-Emitter Voltage	2SB647	-80
		2SB647A	-100
V _{EB0}	Emitter-Base Voltage	-5	V
I _c	Collector Current	-1	A
P _C	Collector Power Dissipation	900	mW
R _{θJA}	Thermal Resistance From Junction To Ambient	139	°C/W
T _j	Junction Temperature	150	°C
T _{stg}	Storage Temperature	-55~+150	°C

ELECTRICAL CHARACTERISTICS

$T_a=25^\circ\text{C}$ unless otherwise specified

Parameter	Symbol	Test conditions	Min	Typ	Max	Unit
Collector-base breakdown voltage	$V_{(BR)CBO}$	$I_C=-10\mu\text{A}, I_E=0$	-120			V
Collector-emitter breakdown voltage	$V_{(BR)CEO}$	$I_C=-1\text{mA}, I_B=0$	2SB647	-80		V
			2SB647A	-100		
Emitter-base breakdown voltage	$V_{(BR)EBO}$	$I_E=-10\mu\text{A}, I_C=0$	-5			V
Collector cut-off current	I_{CBO}	$V_{CB}=-100\text{V}, I_E=0$			-10	μA
DC current gain	$h_{FE(1)}^*$	$V_{CE}=-5\text{V}, I_C=-150\text{mA}$	2SB647	60		320
			2SB647A	60		200
	$h_{FE(2)}^*$	$V_{CE}=-5\text{V}, I_C=-500\text{mA}$	30			
Collector-emitter saturation voltage	$V_{CE(sat)}^*$	$I_C=-500\text{mA}, I_B=-50\text{mA}$			-1	V
Base-emitter voltage	V_{BE}^*	$V_{CE}=-5\text{V}, I_C=-150\text{mA}$			-1.5	V
Collector output capacitance	C_{ob}	$V_{CB}=-10\text{V}, I_E=0, f=1\text{MHz}$		20		pF
Transition frequency	f_T	$V_{CE}=-5\text{V}, I_C=-150\text{mA}$		140		MHz

*Pulse test: pulse width $\leq 300\mu\text{s}$, duty cycle $\leq 2.0\%$.

CLASSIFICATION OF $h_{FE(1)}$

TYPE	2SB647		
	2SB647A		
RANK	B	C	D
RANGE	60-120	100-200	160-320

Typical Characteristics

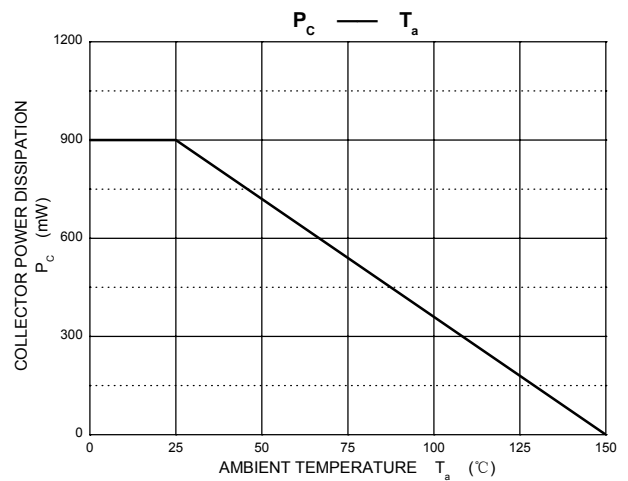
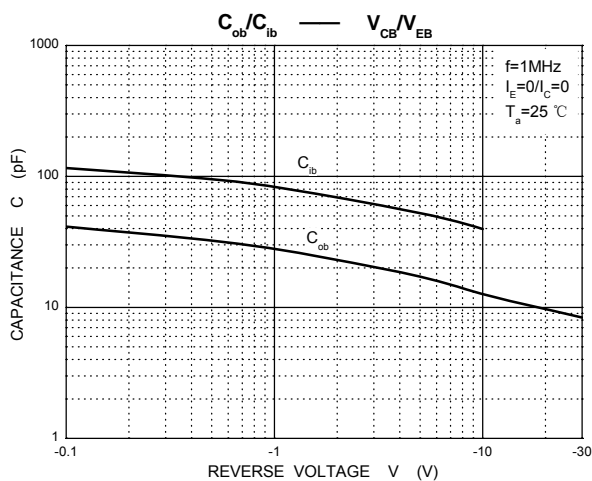
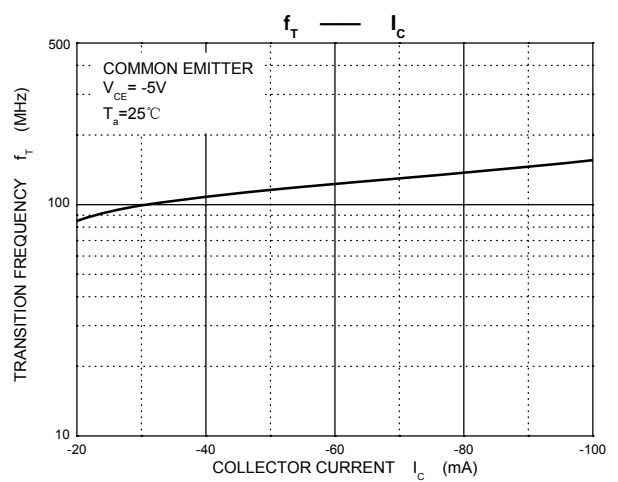
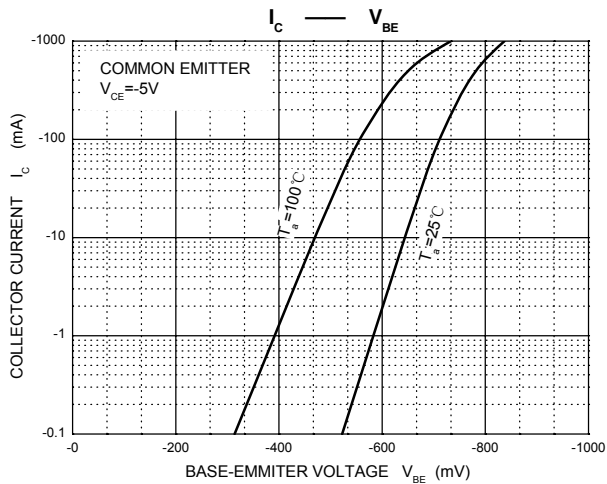
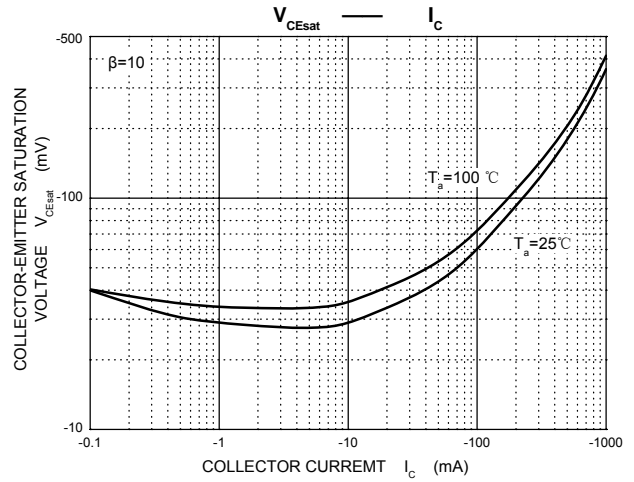
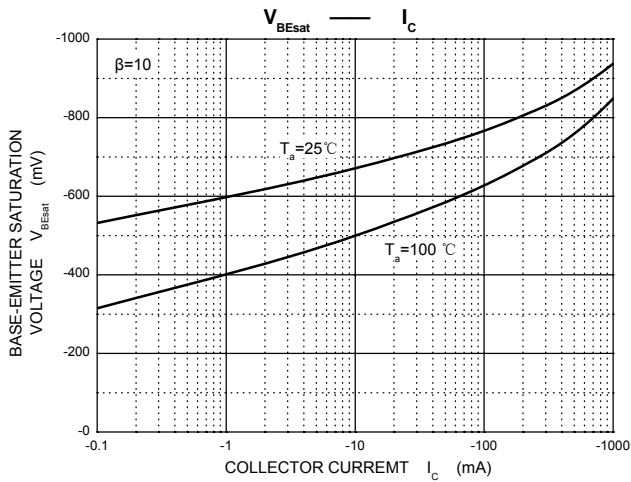
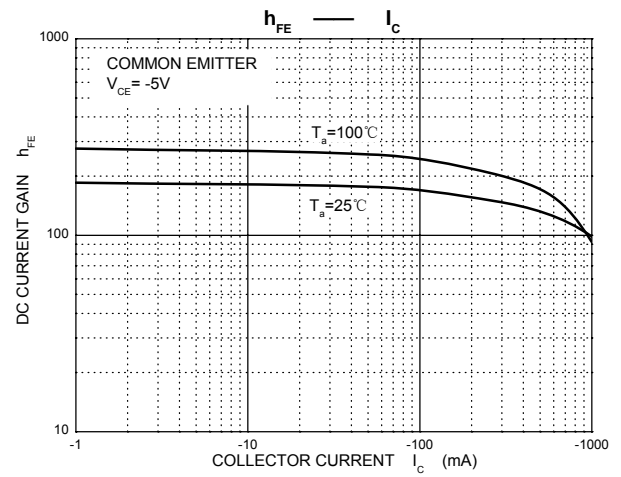
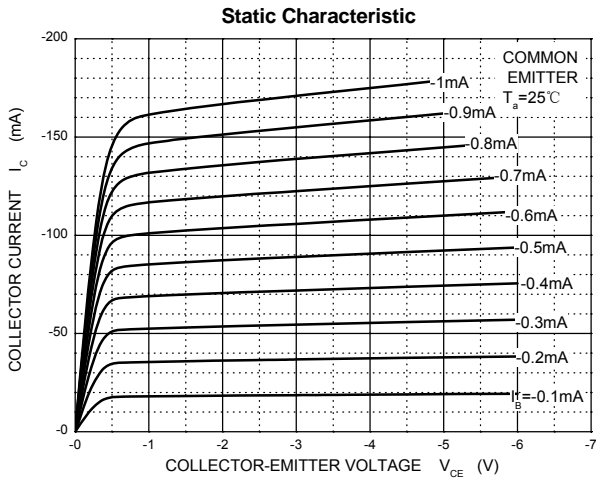

TO-92MOD Package Outline Dimensions

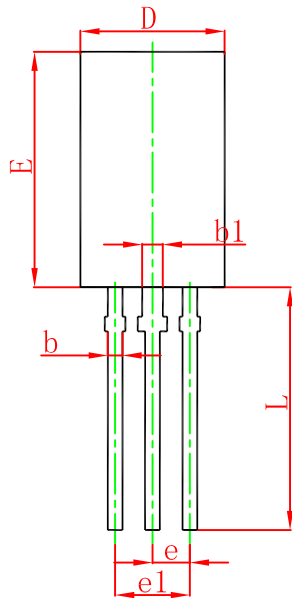
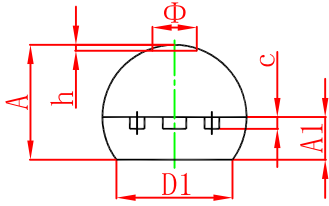

Symbol	Dimensions In Millimeters		Dimensions In Inches	
	Min.	Max.	Min.	Max.
A	4.800	5.000	0.189	0.197
A1	1.730	2.030	0.068	0.080
b	0.440	0.600	0.017	0.024
b1	0.940	1.100	0.037	0.043
c	0.350	0.450	0.014	0.018
D	5.900	6.100	0.232	0.240
D1	4.000		0.157	
E	8.500	8.700	0.335	0.343
e	1.500 TYP.		0.059 TYP.	
e1	2.900	3.100	0.114	0.122
L	13.800	14.200	0.543	0.559
Φ		1.600		0.063
h	0.000	0.380	0.000	0.015

TO-92MOD Suggested Pad Layout

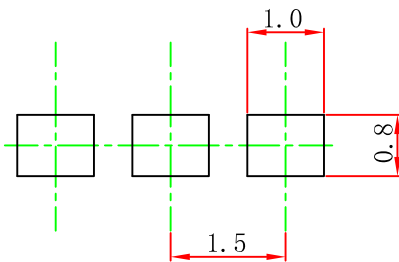

Note:

1. Controlling dimension: in millimeters.
2. General tolerance: ± 0.05 mm.
3. The pad layout is for reference purposes only.

NOTICE

JSCJ reserves the right to make modifications, enhancements, improvements, corrections or other changes without further notice to any product herein. JSCJ does not assume any liability arising out of the application or use of any product described herein.

TO-92MOD PACKAGE TAPING DIMENSION

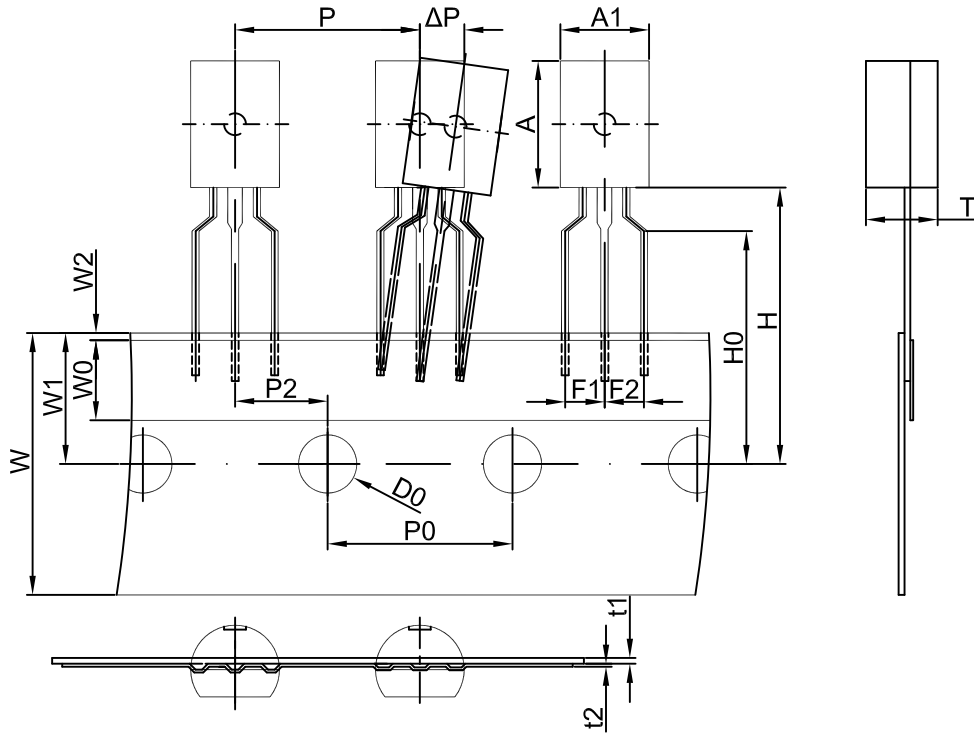

Dimensions are in millimeter

A1	A	T	P	P0	P2	F1	F2	W
6.0	8.6	4.9	12.7	12.7	6.35	2.5	2.5	18.0
W0	W1	W2	H	H0	D0	t1	t2	ΔP
6.0	9.0	1.0	19.0	16.0	4.0	0.4	0.2	0

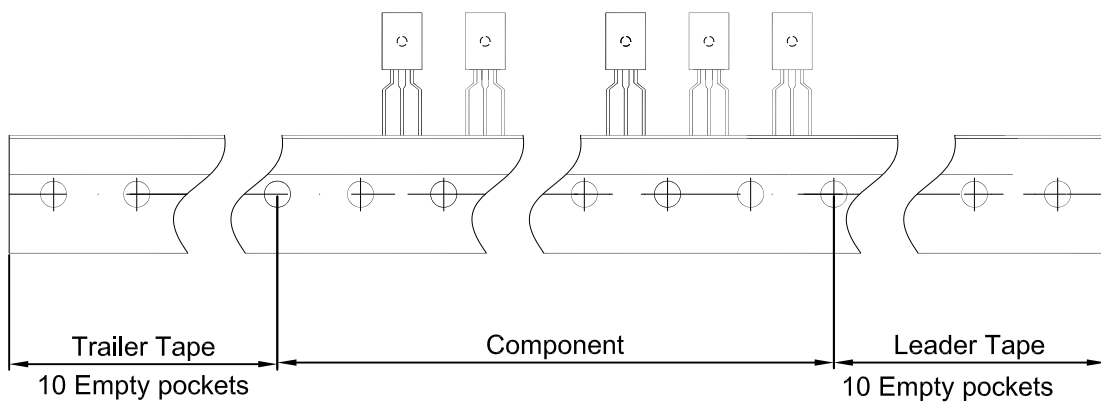

Package	Box	Box Size(mm)	Carton	Carton Size(mm)
TO-92MOD	2000 pcs	333×245×43	20,000 pcs	573×404×266