

2SC1740S TRANSISTOR (NPN)

FEATURES

- Low Cob

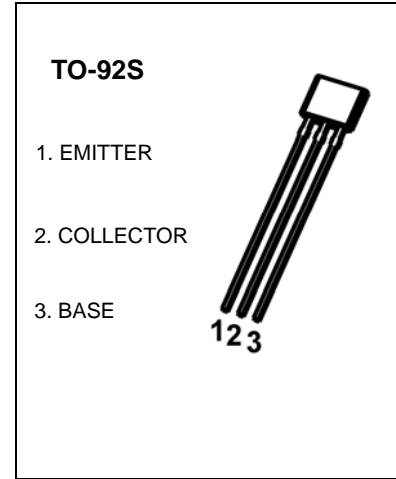

MARKING

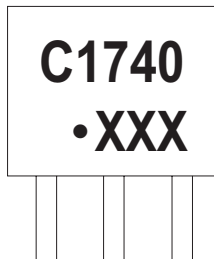

C1740=Device code
 Solid dot= Green molding compound device,
 if none, the normal device
 XXX=Code

Equivalent Circuit

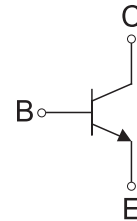

ORDERING INFORMATION

Part Number	Package	Packing Method	Pack Quantity
2SC1740S	TO-92S	Bulk	1000pcs/Bag
2SC1740S-TA	TO-92S	Tape	3000pcs/Box

MAXIMUM RATINGS (T_a=25°C unless otherwise noted)

Symbol	Parameter	Value	Unit
V _{CB0}	Collector-Base Voltage	60	V
V _{CEO}	Collector-Emitter Voltage	50	V
V _{EBO}	Emitter-Base Voltage	7	V
I _C	Collector Current –Continuous	150	mA
P _C	Collector Power Dissipation	300	mW
T _J , T _{stg}	Operation Junction and Storage Temperature Range	-55-150	°C

ELECTRICAL CHARACTERISTICS

$T_a=25^\circ\text{C}$ unless otherwise specified

Parameter	Symbol	Test conditions	Min	Typ	Max	Unit
Collector-base breakdown voltage	$V_{(BR)CBO}$	$I_C=50\mu\text{A}$, $I_E=0$	60			V
Collector-emitter breakdown voltage	$V_{(BR)CEO}$	$I_C=1\text{mA}$, $I_B=0$	50			V
Emitter-base breakdown voltage	$V_{(BR)EBO}$	$I_E=50\mu\text{A}$, $I_C=0$	7			V
Collector cut-off current	I_{CBO}	$V_{CB}=60\text{V}$, $I_E=0$			0.1	μA
Emitter cut-off current	I_{EBO}	$V_{EB}=7\text{V}$, $I_C=0$			0.1	μA
DC current gain	h_{FE}	$V_{CE}=6\text{V}$, $I_C=1\text{mA}$	120		560	
Collector-emitter saturation voltage	$V_{CE(sat)}$	$I_C=50\text{mA}$, $I_B=5\text{mA}$			0.4	V
Transition frequency	f_T	$V_{CE}=12\text{V}$, $I_C=-2\text{mA}$, $f=100\text{MHz}$	100			MHz
Collector output capacitance	C_{ob}	$V_{CB}=12\text{V}$, $I_E=0$, $f=1\text{MHz}$		2	3.5	pF

CLASSIFICATION OF h_{FE}

Rank	Q	R	S
Range	120-270	180-390	270-560

Typical Characteristics

Static Characteristic

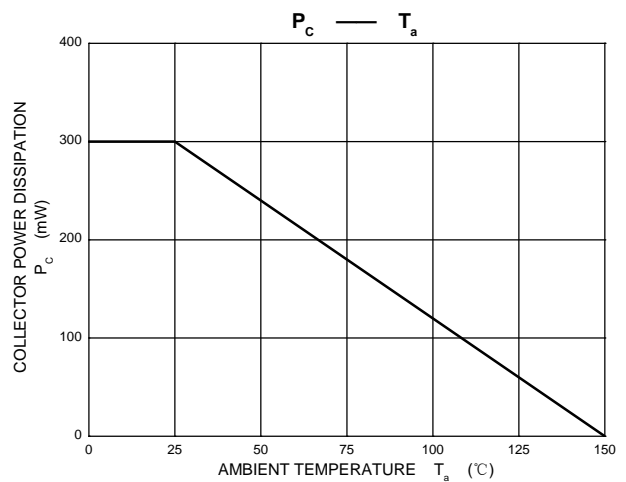
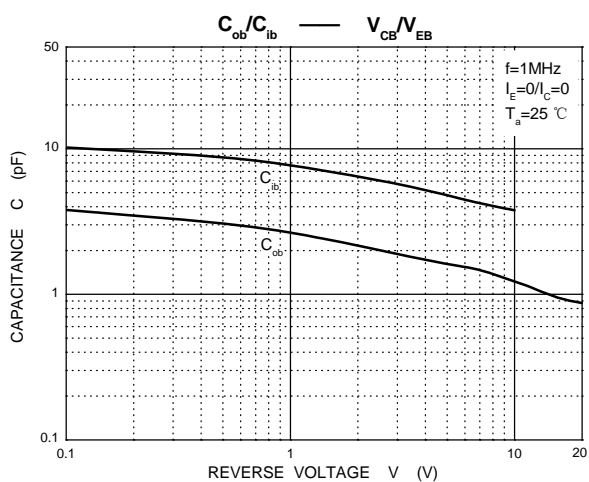
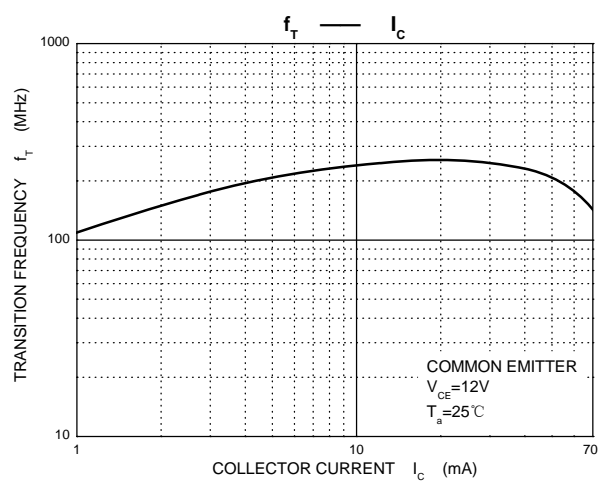
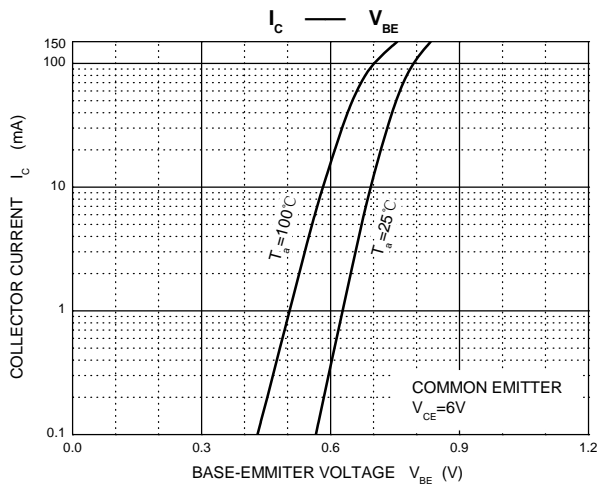
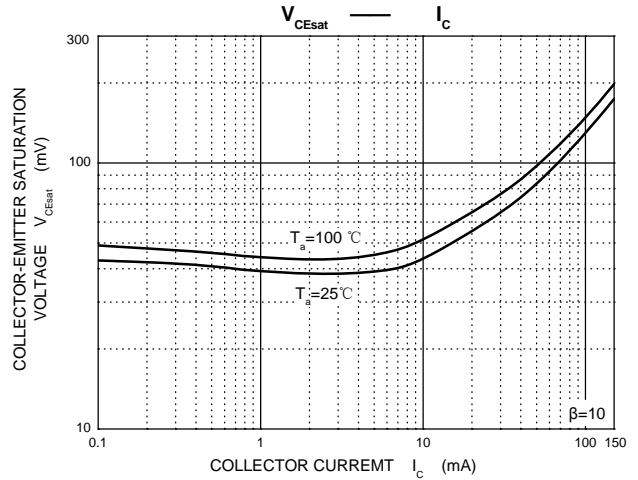
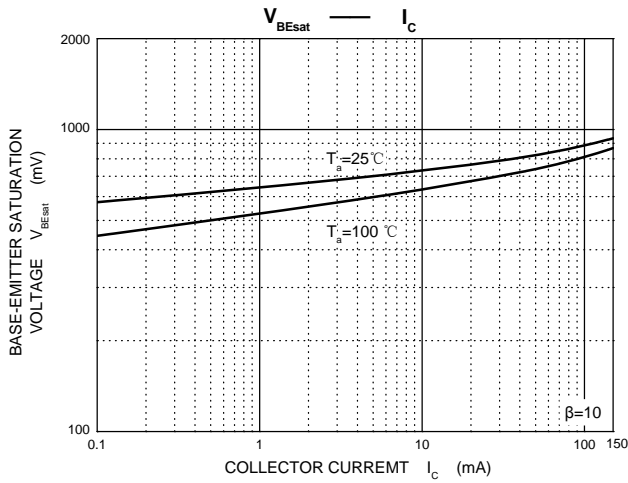
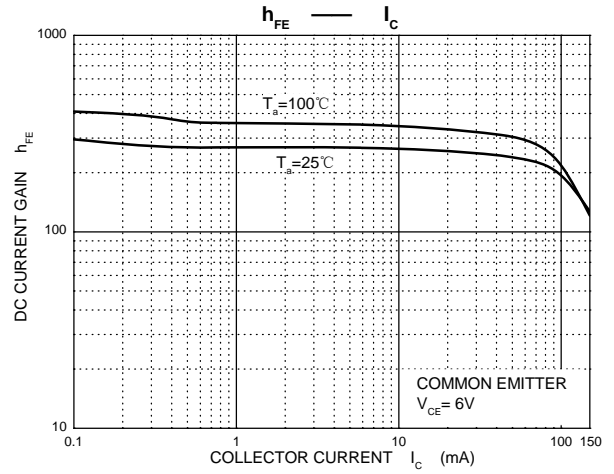
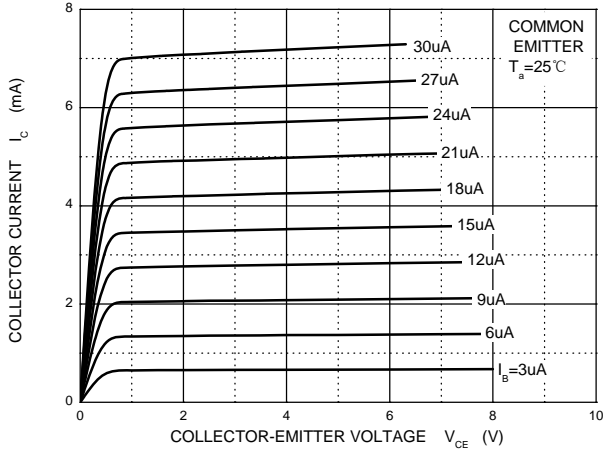

TO-92S Package Outline Dimensions

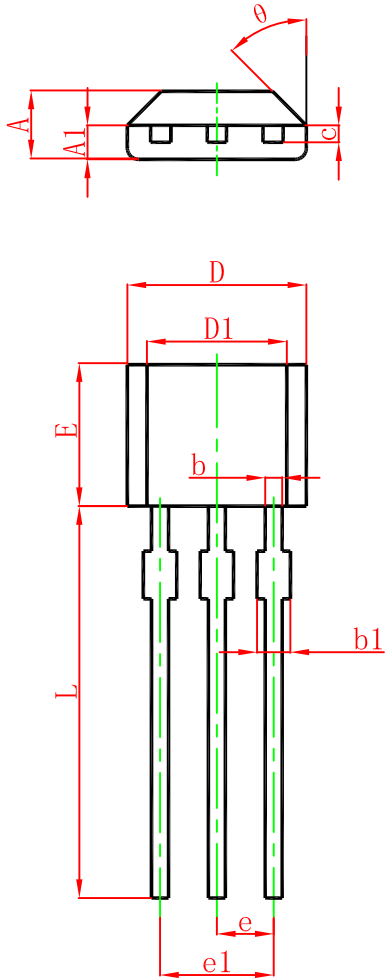

Symbol	Dimensions In Millimeters		Dimensions In Inches	
	Min.	Max.	Min.	Max.
A	1.420	1.620	0.056	0.064
A1	0.660	0.860	0.026	0.034
b	0.330	0.480	0.013	0.019
b1	0.400	0.510	0.016	0.020
c	0.330	0.510	0.013	0.020
D	3.900	4.100	0.154	0.161
D1	2.280	2.680	0.090	0.106
E	3.050	3.250	0.120	0.128
e	1.270 TYP.		0.050 TYP.	
e1	2.440	2.640	0.096	0.104
L	15.100	15.500	0.594	0.610
θ	45° TYP.		45° TYP.	

TO-92S Suggested Pad Layout

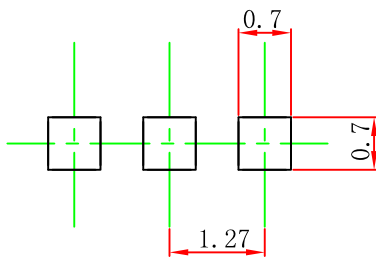

Note:

1. Controlling dimension: in millimeters.
2. General tolerance: ± 0.05 mm.
3. The pad layout is for reference purposes only.

NOTICE

JSCJ reserves the right to make modifications, enhancements, improvements, corrections or other changes without further notice to any product herein. JSCJ does not assume any liability arising out of the application or use of any product described herein.

TO-92S PACKAGE TAPING DIMENSION

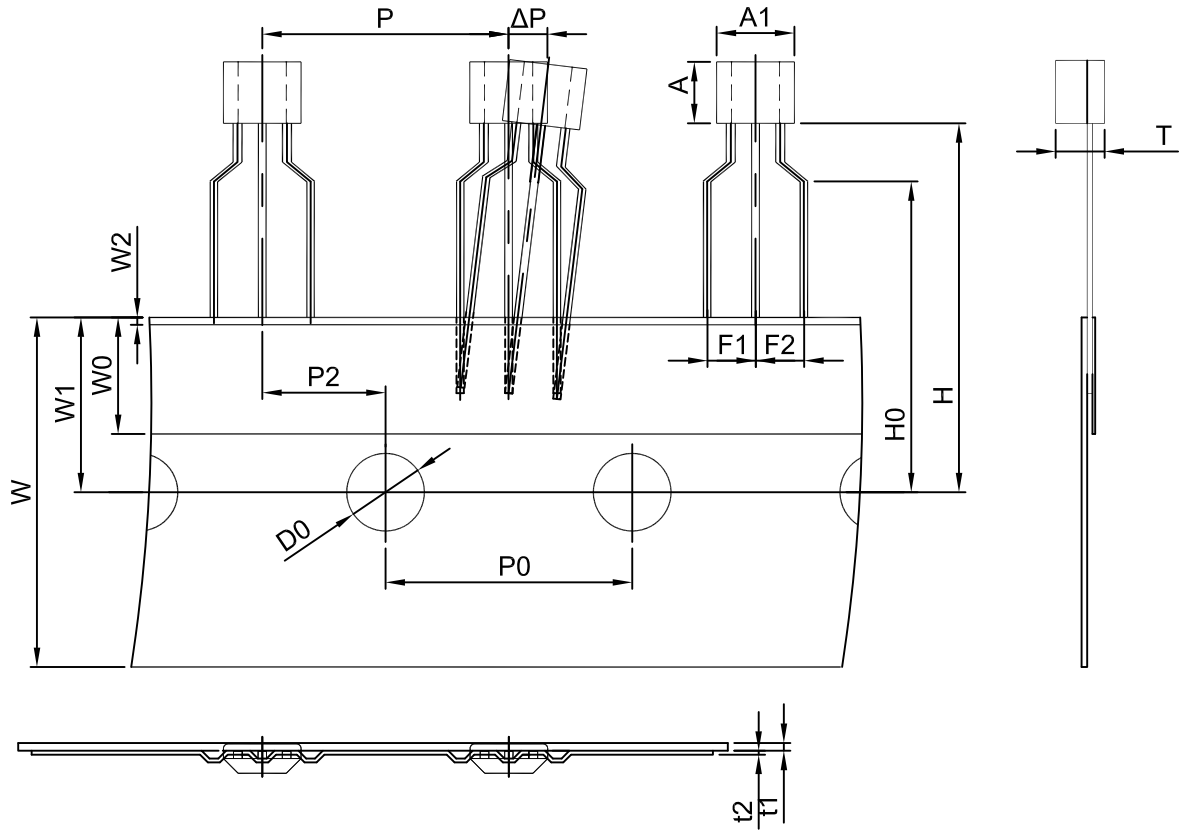

Dimiensions are in millimeter

A1	A	T	P	P0	P2	F1	F2	W
4.0	3.15	1.52	12.7	12.7	6.35	2.5	2.5	18.0
W0	W1	W2	H	H0	D0	t1	t2	ΔP
6.0	9.0	1.0	19.0	16.0	4.0	0.4	0.2	0

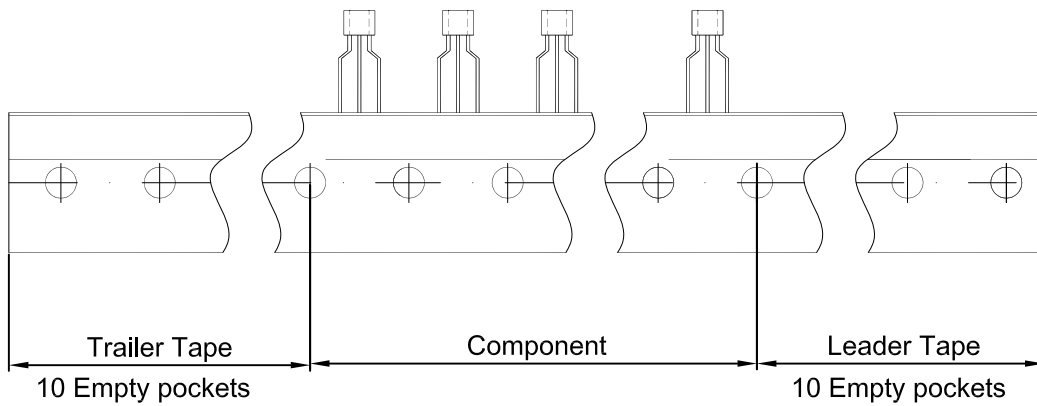

Package	Box	Box Size(mm)	Carton	Carton Size(mm)
TO-92S	3000 pcs	333×162×43	30,000 pcs	350×340×250