



TO-92 Plastic-Encapsulate Transistors

2SC2001 TRANSISTOR (NPN)

FEATURES

- High h_{FE} and Low $V_{CE(sat)}$
 $h_{FE}(I_C=100mA) : 200(Typ)$
 $V_{CE(sat)}(700mA) : 0.2V (Typ)$

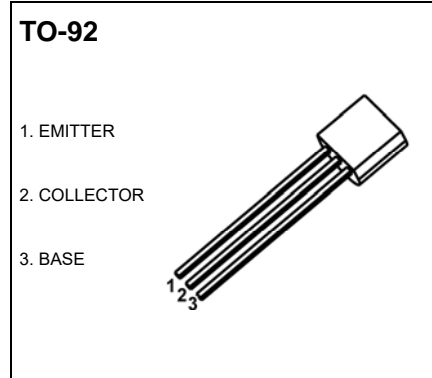

MARKING

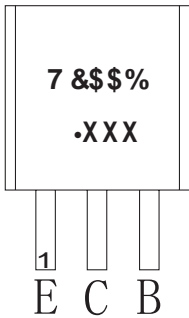

C2001=Device code
 Solid dot=Green molding compound device,
 if none,the normal device
 XXX=Code

Equivalent Circuit

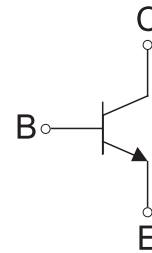

ORDERING INFORMATION

| Part Number | Package | Packing Method | Pack Quantity |
|-------------|---------|----------------|---------------|
| 2SC2001 | TO-92 | Bulk | 1000pcs/Bag |
| 2SC2001-TA | TO-92 | Tape | 2000pcs/Box |

MAXIMUM RATINGS($T_a=25^{\circ}C$ unless otherwise noted)

| Symbol | Parameter | Value | Unit |
|----------------|--|---------|-------------|
| V_{CBO} | Collector-Base Voltage | 30 | V |
| V_{CEO} | Collector-Emitter Voltage | 25 | V |
| V_{EBO} | Emitter-Base Voltage | 5 | V |
| I_C | Collector Current -Continuous | 700 | mA |
| P_C | Collector Power Dissipation | 600 | mW |
| T_J, T_{stg} | Operation Junction and Storage Temperature Range | -55-150 | $^{\circ}C$ |

ELECTRICAL CHARACTERISTICS

$T_a=25^\circ\text{C}$ unless otherwise specified

| Parameter | Symbol | Test conditions | Min | Max | Unit |
|--------------------------------------|---------------|---|-----|-----|---------------|
| Collector-base breakdown voltage | $V_{(BR)CBO}$ | $I_C=100\mu\text{A}, I_E=0$ | 30 | | V |
| Collector-emitter breakdown voltage | $V_{(BR)CEO}$ | $I_C=10\text{mA}, I_B=0$ | 25 | | V |
| Emitter-base breakdown voltage | $V_{(BR)EBO}$ | $I_E=100\mu\text{A}, I_C=0.5$ | | | V |
| Collector cut-off current | I_{CBO} | $V_{CB}=30\text{V}, I_E=0$ | | 0.1 | μA |
| Collector cut-off current | I_{CEO} | $V_{CE}=20\text{V}, I_B=0$ | | 0.1 | μA |
| Emitter cut-off current | I_{EBO} | $V_{EB}=5\text{V}, I_C=0$ | | 0.1 | μA |
| DC current gain | h_{FE} | $V_{CE}=1\text{V}, I_C=100\text{mA}$ | 90 | 400 | |
| Collector-emitter saturation voltage | $V_{CE(sat)}$ | $I_C=700\text{mA}, I_B=70\text{mA}$ | | 0.6 | V |
| Base-emitter saturation voltage | $V_{BE(sat)}$ | $I_C=700\text{mA}, I_B=70\text{mA}$ | | 1.2 | V |
| Transition frequency | f_T | $V_{CE}=6\text{V}, I_C=10\text{mA}$ $f=30\text{MHz}$ | 50 | | MHz |

CLASSIFICATION OF h_{FE}

| Rank | M | L | K |
|-------|--------|---------|---------|
| Range | 90-180 | 135-270 | 200-400 |

Typical Characteristics

Static Characteristic

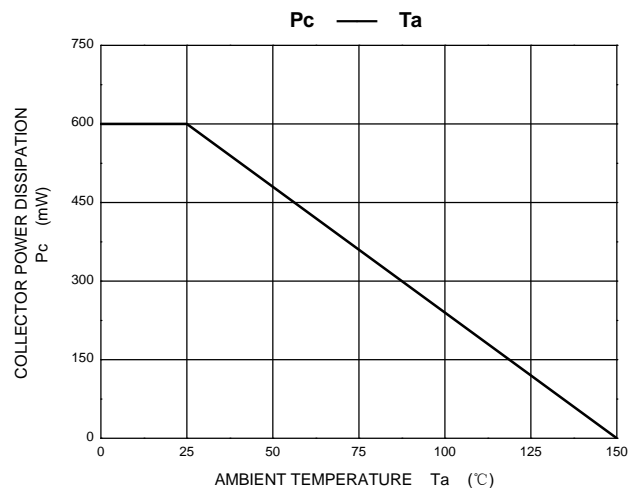
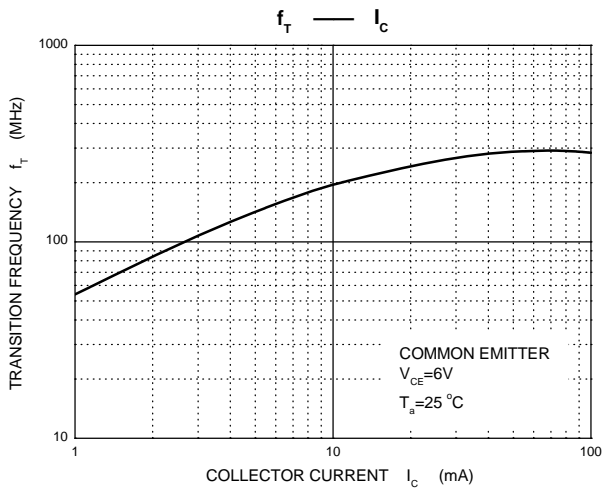
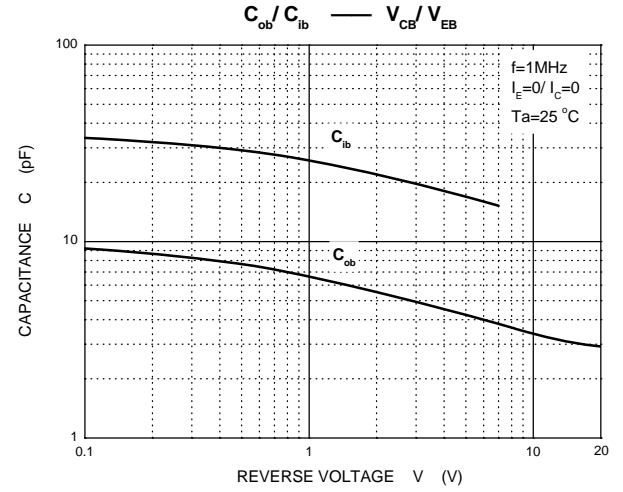
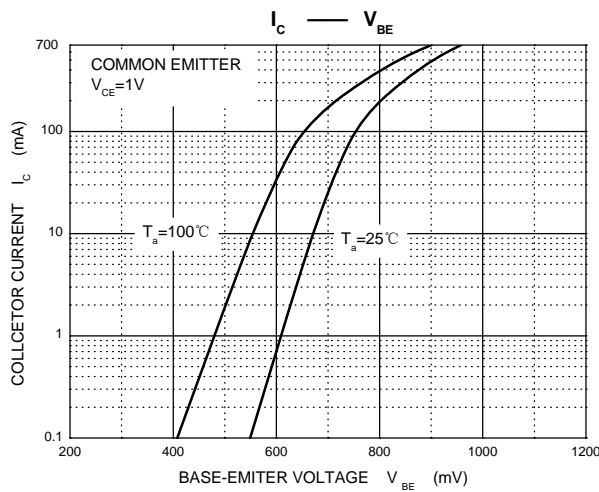
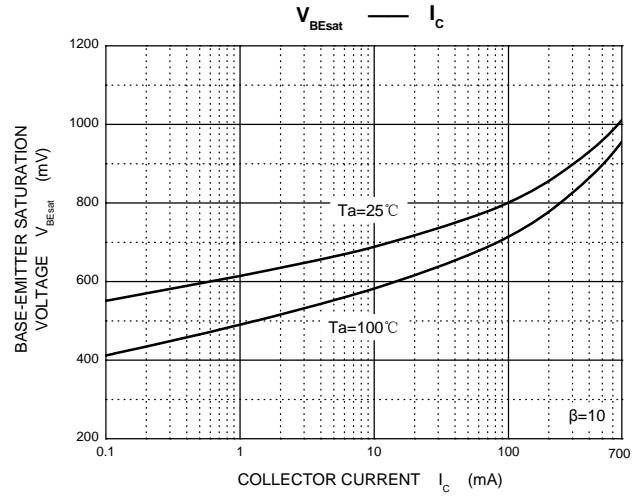
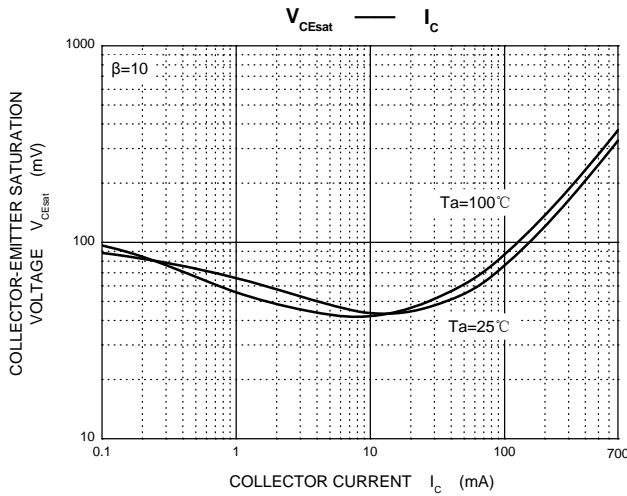
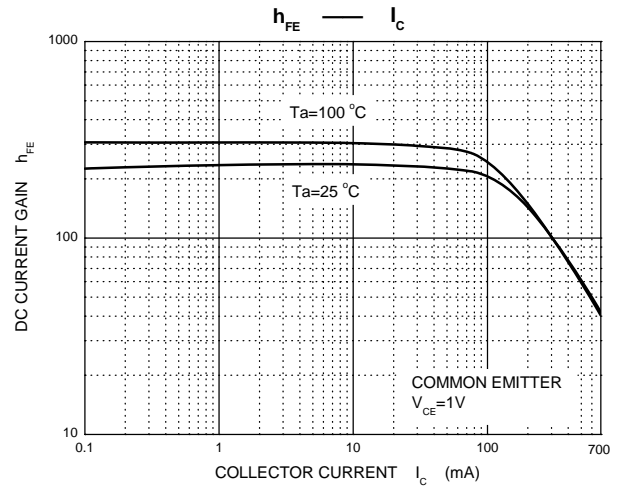
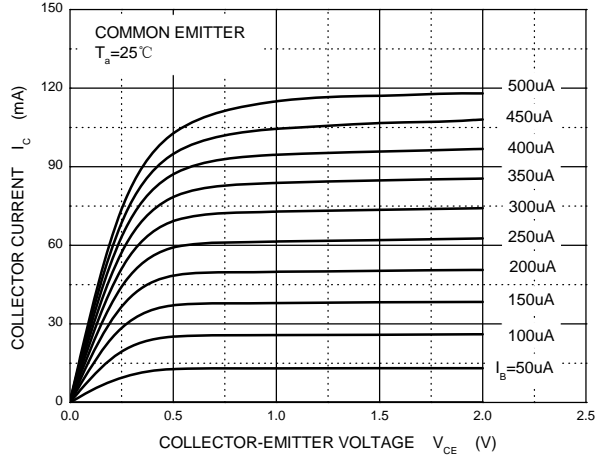

TO-92 Package Outline Dimensions

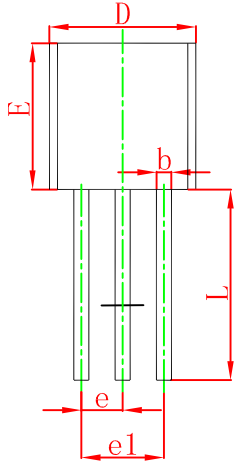
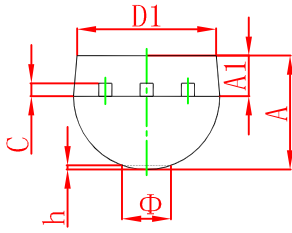

| Symbol | Dimensions In Millimeters | | Dimensions In Inches | |
|--------|---------------------------|--------|----------------------|-------|
| | Min | Max | Min | Max |
| A | 3.300 | 3.700 | 0.130 | 0.146 |
| A1 | 1.100 | 1.400 | 0.043 | 0.055 |
| b | 0.380 | 0.550 | 0.015 | 0.022 |
| c | 0.360 | 0.510 | 0.014 | 0.020 |
| D | 4.300 | 4.700 | 0.169 | 0.185 |
| D1 | 3.430 | | 0.135 | |
| E | 4.300 | 4.700 | 0.169 | 0.185 |
| e | 1.270 TYP | | 0.050 TYP | |
| e1 | 2.440 | 2.640 | 0.096 | 0.104 |
| L | 14.100 | 14.500 | 0.555 | 0.571 |
| Φ | | 1.600 | | 0.063 |
| h | 0.000 | 0.380 | 0.000 | 0.015 |

TO-92 Suggested Pad Layout

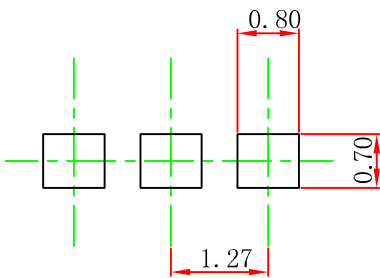

Note:

1. Controlling dimension: in millimeters.
2. General tolerance: $\pm 0.05\text{mm}$.
3. The pad layout is for reference purposes only.

NOTICE

JSCJ reserves the right to make modifications, enhancements, improvements, corrections or other changes without further notice to any product herein. JSCJ does not assume any liability arising out of the application or use of any product described herein.

TO-92 Tape and Reel

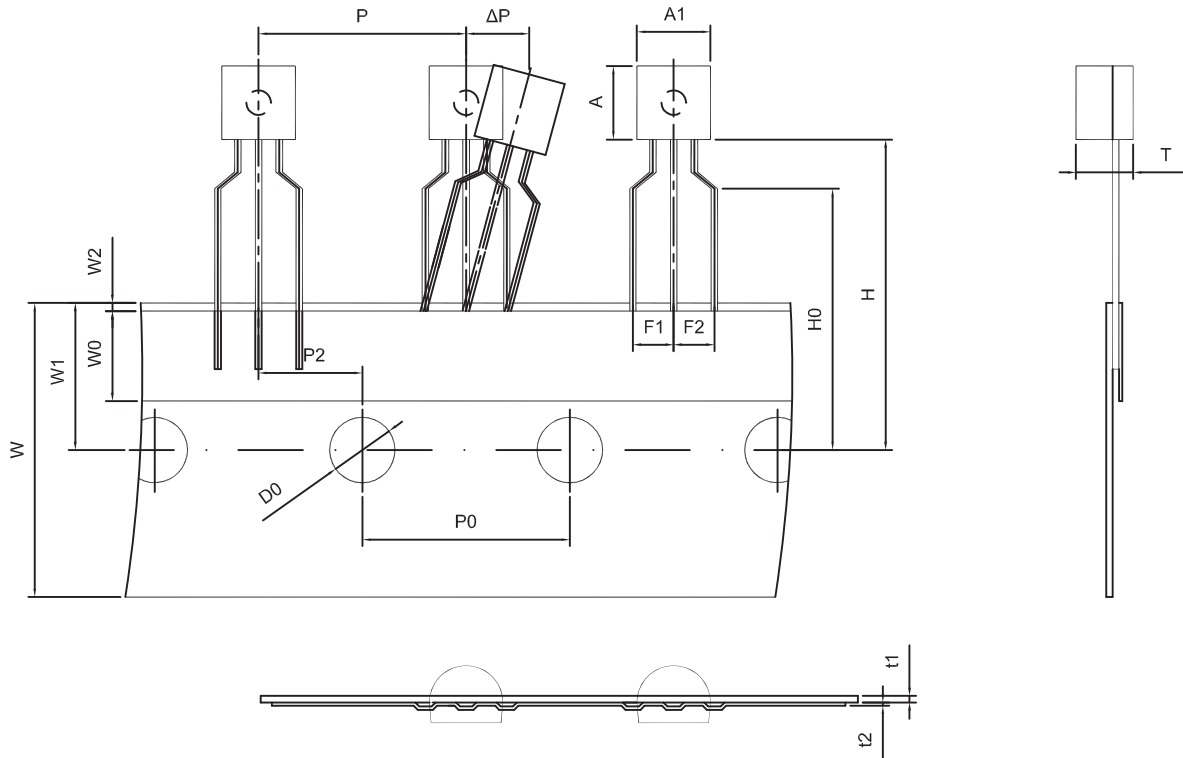

Dimensions are in millimeter

| A1 | A | T | P | P0 | P2 | F1 | F2 | W |
|-----|-----|----------|------|------|------|-----|-----|------|
| 4.5 | 4.5 | 3.5 | 12.7 | 12.7 | 6.35 | 2.5 | 2.5 | 18.0 |
| W0 | W1 | W2 | H | H0 | D0 | t1 | t2 | ΔP |
| 6.0 | 9.0 | 1.0 MAX. | 19.0 | 16.0 | 4.0 | 0.4 | 0.2 | 0 |

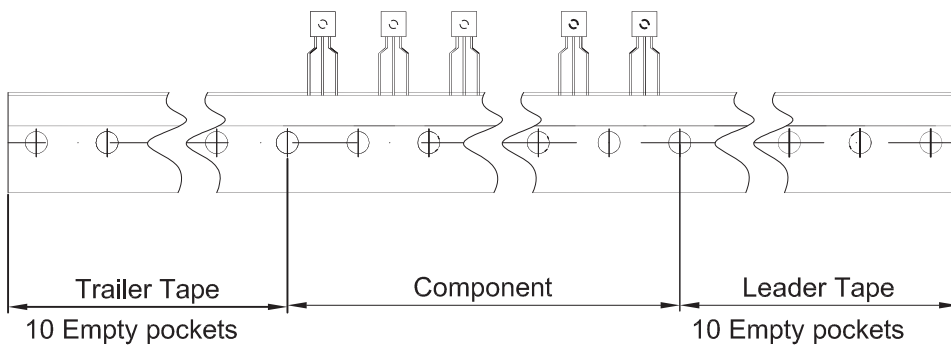

| Package | Box | Box Size(mm) | Carton | Carton Size(mm) |
|---------|----------|--------------|------------|-----------------|
| TO-92 | 2000 pcs | 333×162×43 | 20,000 pcs | 350×340×250 |