

SOT-323 Plastic-Encapsulate Transistors

2SC4102 TRANSISTOR (NPN)

FEATURES

- High Breakdown Voltage
- Complements the 2SA1579

MAXIMUM RATINGS (T_a=25°C unless otherwise noted)

Symbol	Parameter	Value	Unit
V _{CB0}	Collector-Base Voltage	120	V
V _{CEO}	Collector-Emitter Voltage	120	V
V _{EBO}	Emitter-Base Voltage	5	V
I _C	Collector Current	50	mA
P _C	Collector Power Dissipation	200	mW
R _{θJA}	Thermal Resistance From Junction To Ambient	625	°C/W
T _J , T _{stg}	Operation Junction and Storage Temperature Range	-55~+150	°C

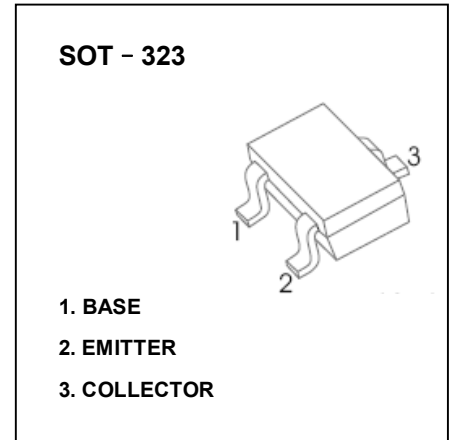

ELECTRICAL CHARACTERISTICS (T_a=25°C unless otherwise specified)

Parameter	Symbol	Test conditions	Min	Typ	Max	Unit
Collector-base breakdown voltage	V _{(BR)CBO}	I _C =50μA, I _E =0	120			V
Collector-emitter breakdown voltage	V _{(BR)CEO}	I _C =1mA, I _B =0	120			V
Emitter-base breakdown voltage	V _{(BR)EBO}	I _E =50μA, I _C =0	5			V
Collector cut-off current	I _{CB0}	V _{CB} =100V, I _E =0			500	nA
Emitter cut-off current	I _{EBO}	V _{EB} =4V, I _C =0			500	nA
DC current gain	h _{FE}	V _{CE} =6V, I _C =2mA	180		560	
Collector-emitter saturation voltage	V _{CE(sat)}	I _C =10mA, I _B =1mA			0.5	V
Transition frequency	f _T	V _{CE} =12V, I _C =2mA, f=100MHz		140		MHz
Collector output capacitance	C _{ob}	V _{CB} =12V, I _E =0, f=1MHz		2.5		pF

CLASSIFICATION OF h_{FE}

RANK	R	S
RANGE	180 - 390	270 - 560
MARKING	TR	TS

Typical Characteristics

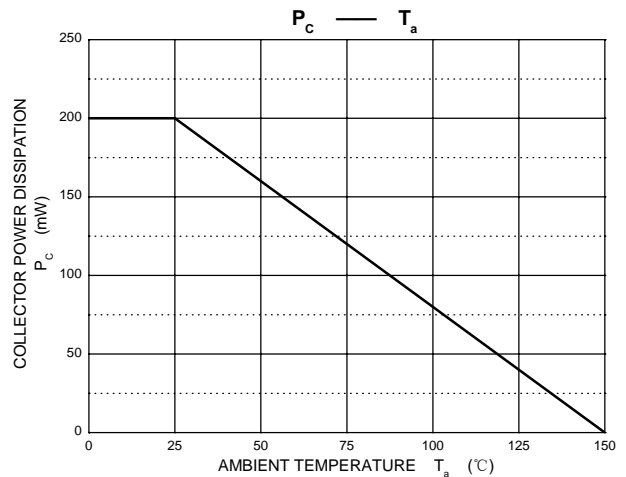
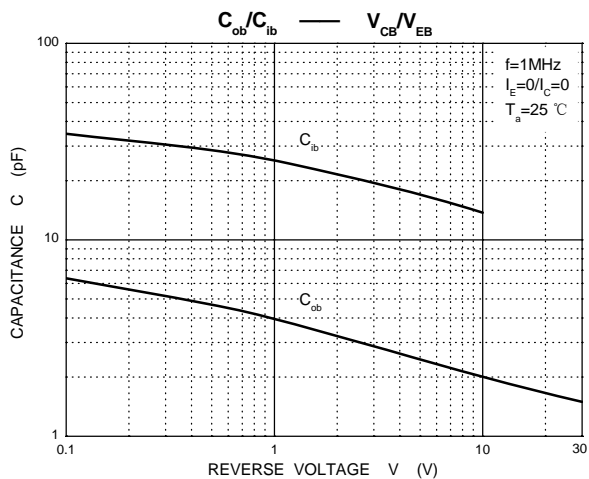
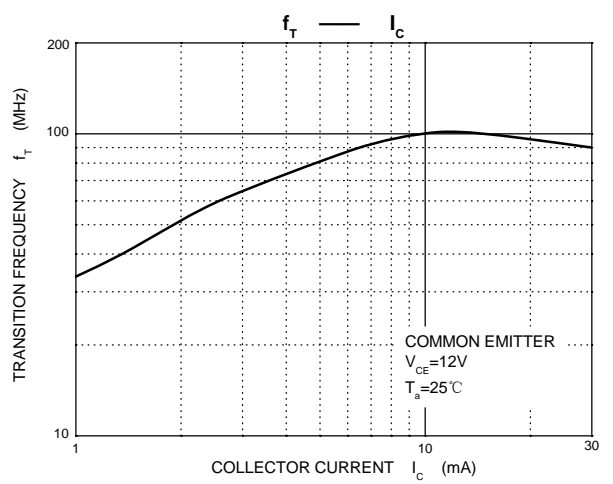
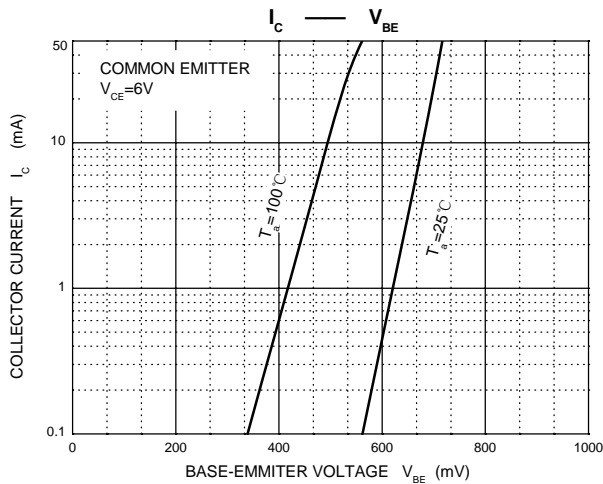
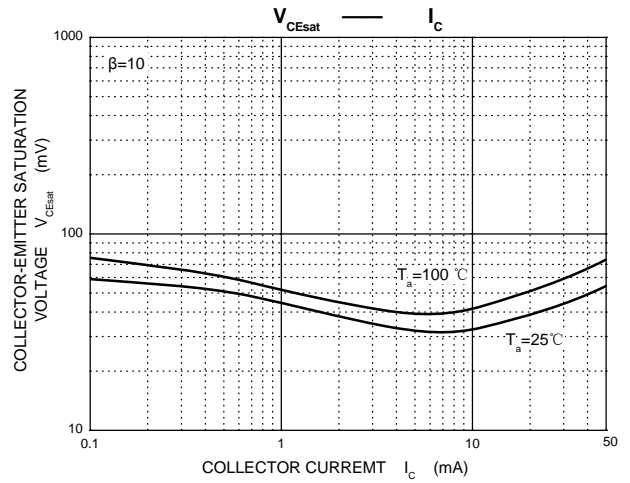
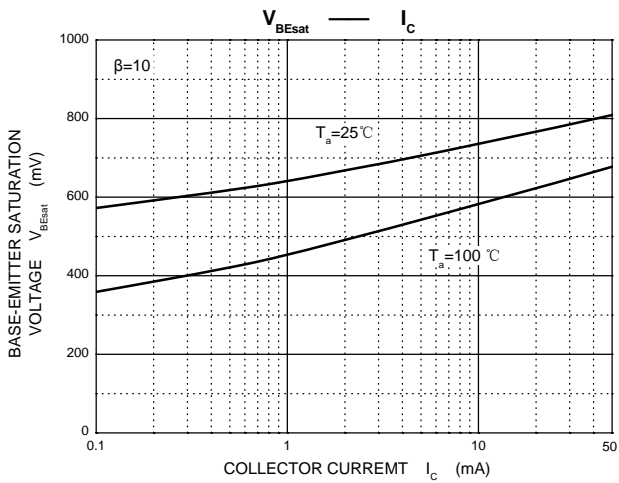
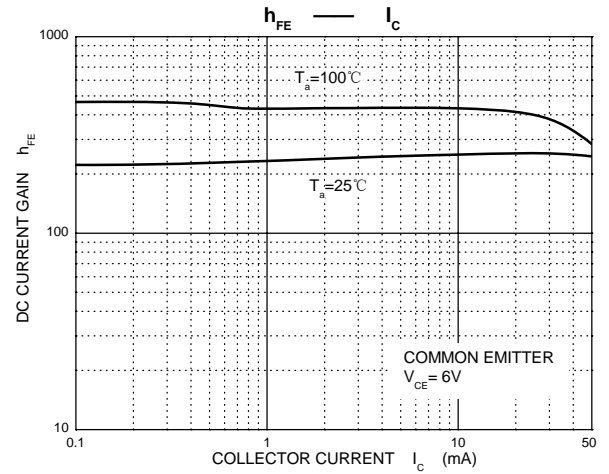
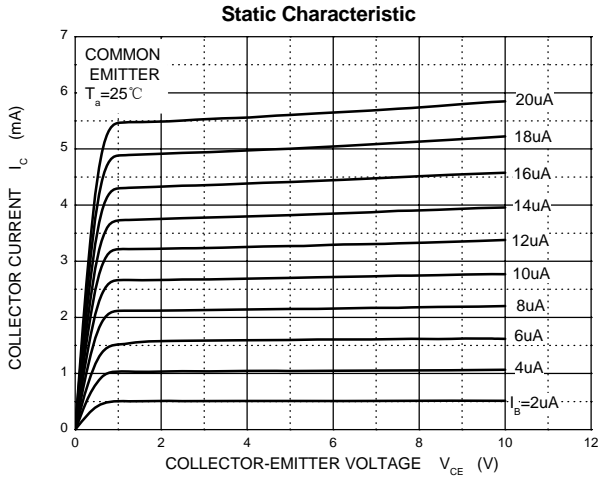

SOT-323 Package Outline Dimensions

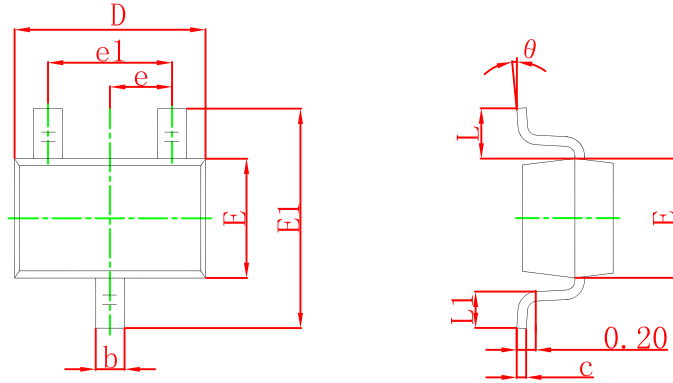

Symbol	Dimensions In Millimeters		Dimensions In Inches	
	Min	Max	Min	Max
A	0.900	1.100	0.035	0.043
A1	0.000	0.100	0.000	0.004
A2	0.900	1.000	0.035	0.039
b	0.200	0.400	0.008	0.016
c	0.080	0.150	0.003	0.006
D	2.000	2.200	0.079	0.087
E	1.150	1.350	0.045	0.053
E1	2.150	2.450	0.085	0.096
e	0.650 TYP		0.026 TYP	
e1	1.200	1.400	0.047	0.055
L	0.525 REF		0.021 REF	
L1	0.260	0.460	0.010	0.018
θ	0°	8°	0°	8°

SOT-323 Suggested Pad Layout

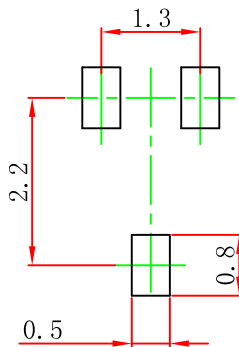

Note:

1. Controlling dimension: in millimeters.
2. General tolerance: ± 0.05 mm.
3. The pad layout is for reference purposes only.

NOTICE

JSCJ reserves the right to make modifications, enhancements, improvements, corrections or other changes without further notice to any product herein. JSCJ does not assume any liability arising out of the application or use of any product described herein.

SOT-323 Tape and Reel

SOT-323 Embossed Carrier Tape

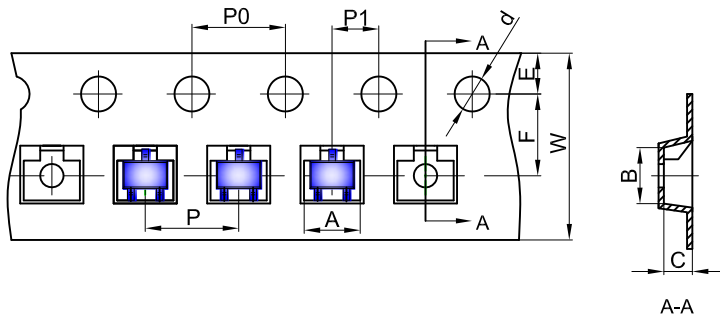

Packaging Description:
 SOT-323 parts are shipped in tape. The carrier tape is made from a dissipative (carbon filled) polycarbonate resin. The cover tape is a multilayer film (Heat Activated Adhesive in nature) primarily composed of polyester film, adhesive layer, sealant, and anti-static sprayed agent. These reeled parts in standard option are shipped with 3,000 units per 7" or 17.8cm diameter reel. The reels are clear in color and is made of polystyrene plastic (anti-static coated).

Dimensions are in millimeter										
Pkg type	A	B	C	d	E	F	P0	P	P1	W
SOT-323	2.25	2.55	1.19	Ø1.55	1.75	3.50	4.00	4.00	2.00	8.00

SOT-323 Tape Leader and Trailer

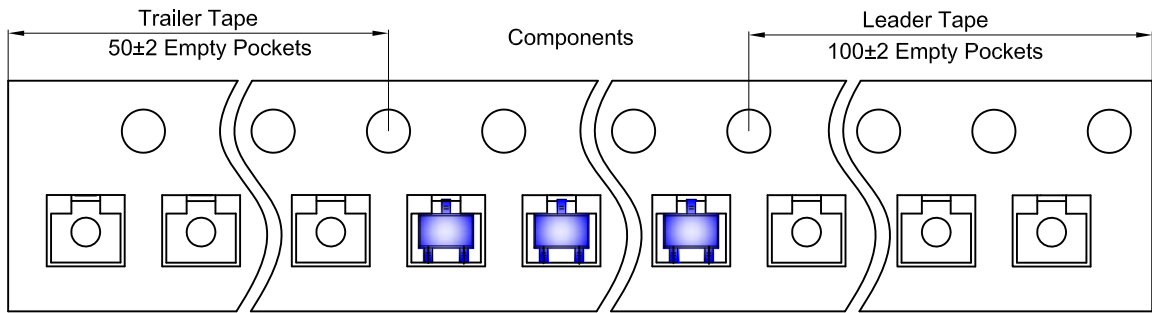

SOT-323 Reel

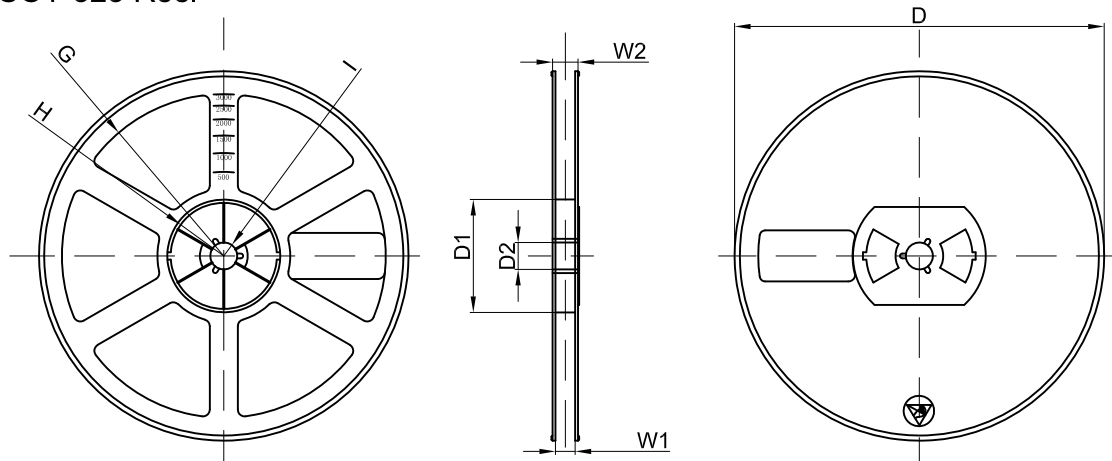

Dimensions are in millimeter								
Reel Option	D	D1	D2	G	H	I	W1	W2
7" Dia	Ø178.00	54.40	13.00	R78.00	R25.60	R6.50	9.50	12.30

REEL	Reel Size	Box	Box Size(mm)	Carton	Carton Size(mm)	G.W.(kg)
3000 pcs	7 inch	45,000 pcs	203×203×195	180,000 pcs	438×438×220	