



## AD-ESDBL3V3D5 Plastic-Encapsulated Diode

### AD-ESDBL3V3D5 Bi-direction ESD protection diode

#### DESCRIPTION

To protect voltage sensitive electronic components from ESD and other transients. Excellent clamping capability, low leakage, low capacitance and fast response time provide best in class protection on designs which are exposed to ESD.

The combination of small size, low capacitance and high level of ESD protection makes the product a flexible solution for applications such as HDMI, Display Port TM and MDDI interfaces. It is designed to replace multilayer varistors (MLV) in consumer equipments applications such as mobile phone, notebook, PAD, STB, LCD TV etc.

#### FEATURES

- Bi-directional ESD protection of one line
- Low capacitance: 15pF(TYP.)
- Reverse stand-off voltage: 3.3V
- Low reverse clamping voltage
- Low leakage current
- Excellent package: 1.20mm X 0.80mm X 0.60mm
- Fast response time
- JESD22-A114-B ESD rating of class 3B per human body model
- IEC 61000-4-2 level 4 ESD protection
- AEC-Q101 qualified

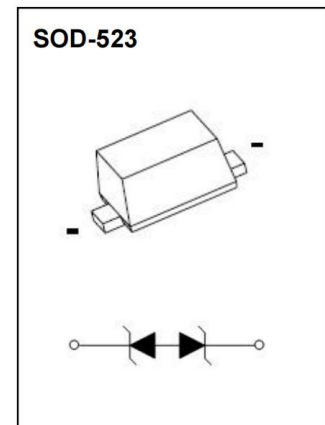

#### APPLICATIONS

- Computers and peripherals
- High speed data lines
- Audio and video equipment
- Cellular handsets and accessories
- Subscriber identity module(SIM) card protection
- Portable electronics
- FireWire
- Other electronics equipment communication systems

**MARKING**

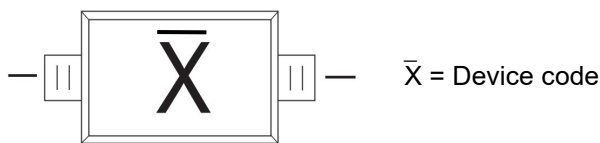

Front side

**MAXIMUM RATINGS (T<sub>j</sub> = 25°C unless otherwise specified)**

Parameter	Symbol	Value	Unit
IEC 61000-4-2 ESD voltage	V <sub>ESD</sub> <sup>1)</sup>	±25	kV
		±25	
		±16	
		±0.4	
JESD22-A114-B ESD voltage per human body model			
ESD voltage per machine model			
Peak pulse power	P <sub>PP</sub> <sup>2)</sup>	70	W
Peak pulse current	I <sub>PP</sub> <sup>2)</sup>	7	A
Maximum lead solder temperature (10 second duration)	T <sub>L</sub>	260	°C
Operation junction and storage temperature range	T <sub>j</sub> , T <sub>stg</sub>	-55 ~ 150	°C

1).Device stressed with ten non-repetitive ESD pulses.  
 2).Non-repetitive current pulse 8/20μs exponential decay waveform according to IEC61000-4-5.

**ESD STANDARD COMPLIANCE**

**IEC61000-4-2 standard**

Contact discharge		Air discharge	
Level	Test voltage (kV)	Level	Test voltage (kV)
1	2	1	2
2	4	2	4
3	6	3	8
4	8	4	15

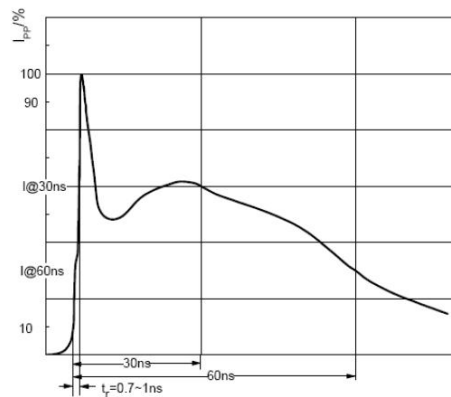

**ESD pulse waveform according to IEC61000-4-2**

**JESD22-A114-B standard**

ESD class	Human body discharge (V)
0	0 ~ 249
1A	250 ~ 499
1B	500 ~ 999
1C	1000 ~ 1999
2	2000 ~ 3999
3A	4000 ~ 7999
3B	8000 ~ 15999

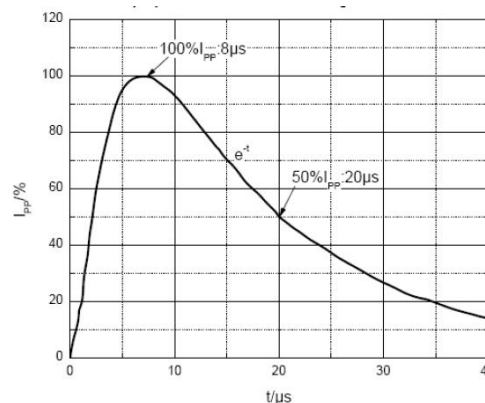

**8/20μs pulse waveform according to IEC 61000-4-5**

**ELECTRICAL CHARACTERISTICS ( $T_j = 25^\circ\text{C}$  unless otherwise specified)**

Parameter	Symbol
Clamping voltage @ $I_{PP}$	$V_C$
Peak pulse current	$I_{PP}$
Breakdown voltage @ $I_T$	$V_{BR}$
Test current	$I_T$
Reverse leakage current @ $V_{RWM}$	$I_R$
Reverse standoff voltage	$V_{RWM}$

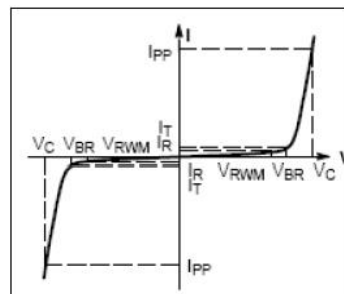
**V-I characteristics for a Bi-directional TVS**

Parameter	Symbol	Test condition	Min	Typ	Max	Unit
Reverse standoff voltage	$V_{RWM}^{1)}$		-	-	3.3	V
Reverse leakage current	$I_R$	$V_{RWM} = 3.3\text{V}$	-	-	0.4	$\mu\text{A}$
Breakdown voltage	$V_{BR}$	$I_T = 1\text{mA}$	4	-	6	V
Clamping voltage	$V_C^{2)}$	$I_{PP} = 7\text{A}$	-	-	10	V
Junction capacitance	$C_J$	$V_R = 0\text{V}, f = 1\text{MHz}$	-	15	20	pF

1). Other voltages available upon request.

2). Non-repetitive current pulse 8/20 $\mu\text{s}$  exponential decay waveform according to IEC61000-4-5

# TYPICAL CHARACTERISTICS

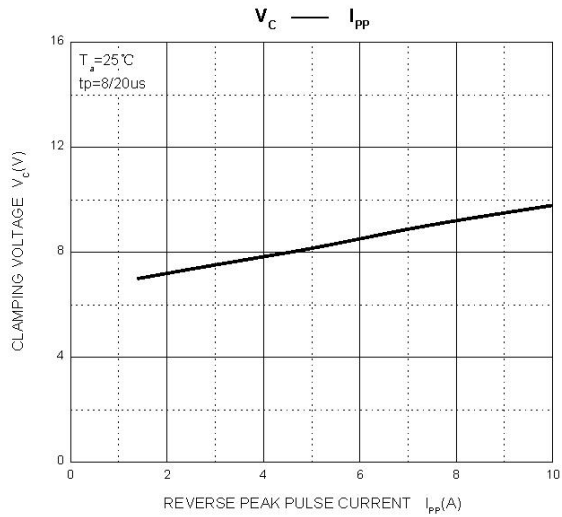
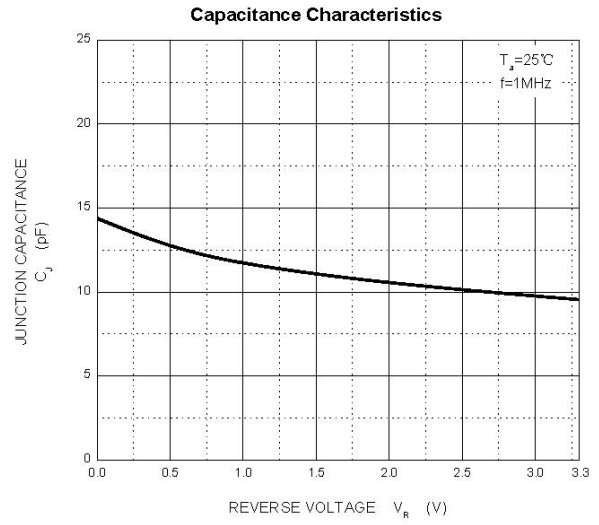
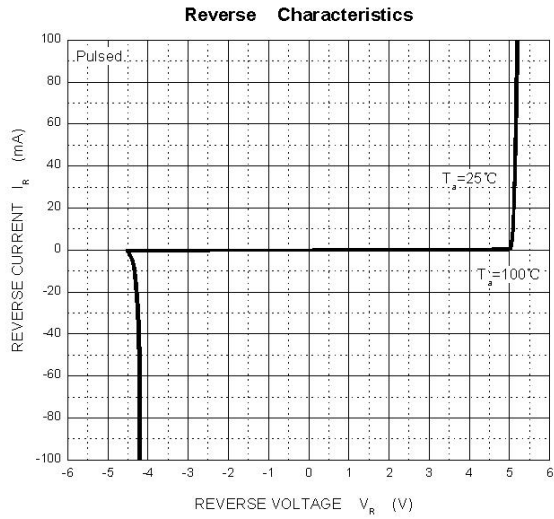

### SOD-523 PACKAGE OUTLINE DIMENSIONS

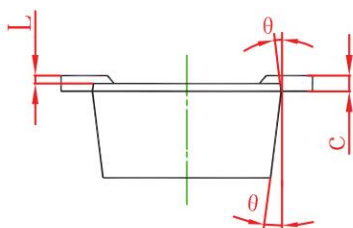
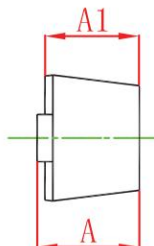
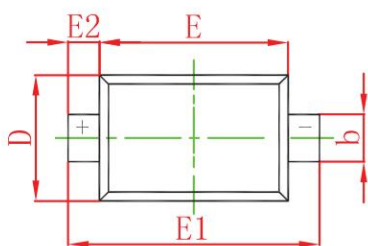

Symbol	Dimensions In Millimeters		Dimensions In Inches	
	Min	Max	Min	Max
A	0.510	0.770	0.020	0.031
A1	0.500	0.700	0.020	0.028
b	0.250	0.350	0.010	0.014
c	0.080	0.150	0.003	0.006
D	0.750	0.850	0.030	0.033
E	1.100	1.300	0.043	0.051
E1	1.500	1.700	0.059	0.067
E2	0.200 REF		0.008 REF	
L	0.010	0.070	0.001	0.003
θ	7° REF		7° REF	

### SOD-523 SUGGESTED PAD LAYOUT

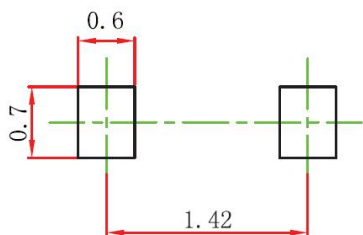

Note:

1. Controlling dimension in millimeters.
2. General tolerance:  $\pm 0.05\text{mm}$ .
3. The pad layout is for reference purpose only.

### SOD-523 TAPE AND REEL

#### SOD-523 Embossed Carrier Tape

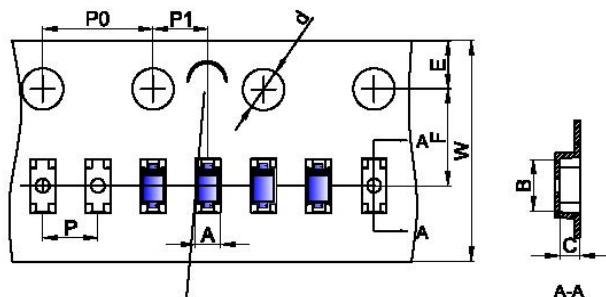

**Packaging Description:**  
 SOD-523 parts are shipped in tape. The carrier tape is made from a dissipative (carbon filled) polycarbonate resin. The cover tape is a multilayer film (Heat Activated Adhesive in nature) primarily composed of polyester film, adhesive layer, sealant, and anti-static sprayed agent. These reeled parts in standard option are shipped with 8,000 units per 7" or 17.8cm diameter reel. The reels are clear in color and is made of polystyrene plastic (anti-static coated).

NOTE: TO CAVE 'C' ON CARRIER TAPE PER 120MM

Dimensions are in millimeter										
Pkg type	A	B	C	d	E	F	P0	P	P1	W
SOD-523	0.9	1.94	0.73	Ø1.50	1.75	3.50	4.00	2.00	2.00	8.00

#### SOD-523 Tape Leader and Trailer

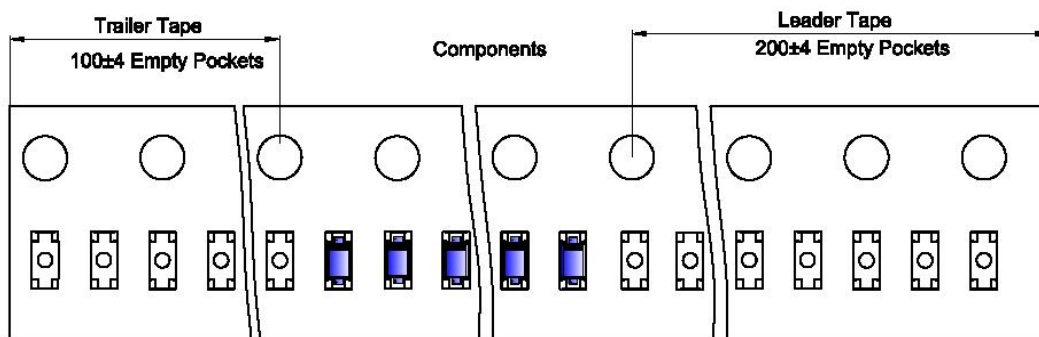

#### SOD-523 Reel

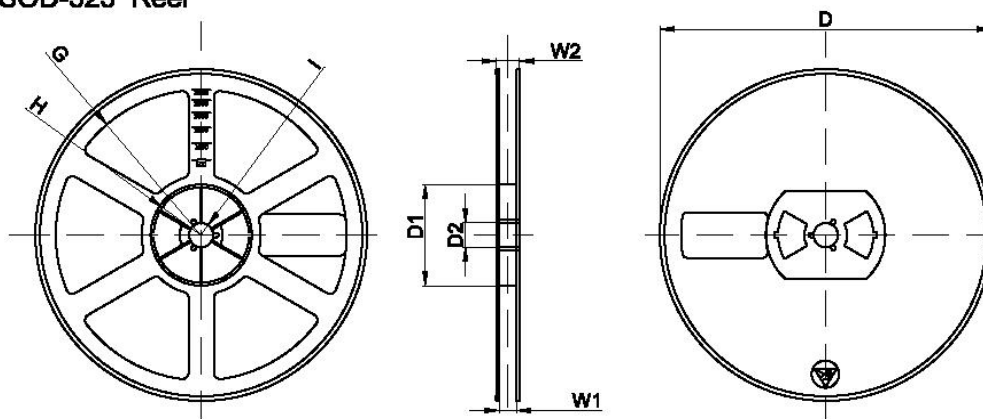

Dimensions are in millimeter								
Reel Option	D	D1	D2	G	H	I	W1	W2
7" Dia	Ø178.00	54.40	13.00	R78.00	R25.80	R8.50	9.50	12.30

REEL	Reel Size	Box	Box Size(mm)	Carton	Carton Size(mm)	G.W.(kg)
8000 pcs	7 Inch	120,000 pcs	203×203×195	480,000 pcs	438×438×220	

**PUBLISHED BY****JIANGSU CHANGJING ELECTRONICS TECHNOLOGY CO., LTD.**

13th Floor, C Block, Tengfei Building, Yan Chuang Yuan, Nanjing Jiangbei New Area, China

**LEGAL DISCLAIMER**

The information given in this document shall in no event be regarded as a guarantee of conditions or characteristics. With respect to any examples, hints or typical values stated herein and/or any information regarding the application of the device, JSCJ hereby disclaims any and all warranties and liabilities of any kind, including without limitation, warranties of non-infringement of intellectual property rights of any third party.

In addition, any information given in this document is subject to customer's compliance with its obligations stated in this document and any applicable legal requirements, norms and standards concerning customer's products and any use of the product of JSCJ in customer's applications.

The data contained in this document is exclusively intended for technically trained staff. It is the responsibility of customer's technical departments to evaluate the suitability of the product for the intended application and the completeness of the product information given in this document with respect to such application.

**INFORMATION**

For further information on technology, delivery terms and conditions as well as prices, please contact your nearest JSCJ office ([www.jscj-elec.com](http://www.jscj-elec.com)).

**WARNINGS**

Due to technical requirements, products may contain dangerous substances. For information on the types in question, please contact your nearest JSCJ office.

Except as otherwise explicitly approved by JSCJ in a written document signed by authorized representatives of JSCJ, JSCJ's products may not be used in any applications where a failure of the product or any consequences of the use thereof can reasonably be expected to result in personal injury.