



AD-SBDD10100CT Plastic-Encapsulated Diode

AD-SBDD10100CT Schottky barrier diode

MAIN CHARACTERISTICS

I_o	10A (2X5A)
V_{RRM}	100V
T_j	150°C
$V_{F(typ)}$	0.63V (@ $T_j = 125^\circ\text{C}$)

FEATURES

- Low power loss, high efficiency
- High current capability and low forward voltage drop
- Guard ring die construction for transient protection
- AEC-Q101 qualified

MARKING

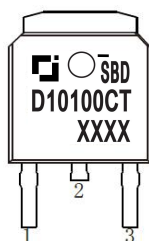

SBDD10100CT = Device code

XXXX = Date code

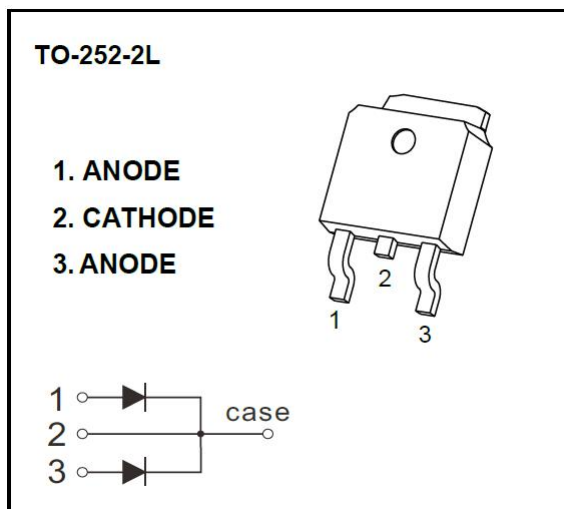

MAXIMUM RATINGS ($T_j = 25^\circ\text{C}$ unless otherwise specified)

Parameter	Symbol	Value	Unit
Peak repetitive reverse voltage	V_{RRM}	100	V
Working peak reverse voltage	V_{RWM}		
DC blocking voltage	V_R		
RMS reverse voltage	$V_{R(RMS)}$	70	V
Average rectified output current	I_O	10	A
Non-repetitive peak forward surge current @ $t = 8.3\text{ms}$	I_{FSM}	120	A
Thermal resistance from junction to case	$R_{\theta JC}$	5.0	$^\circ\text{C/W}$
Thermal resistance from junction to ambient	$R_{\theta JA}$	100	$^\circ\text{C/W}$
Operating junction temperature range	T_j	150	$^\circ\text{C}$
Storage temperature range	T_{stg}	-55 ~ +150	$^\circ\text{C}$

ELECTRICAL CHARACTERISTICS ($T_j = 25^\circ\text{C}$ unless otherwise specified)

Parameter	Symbol	Test condition	Min	Typ	Max	Unit	
Reverse breakdown voltage	$V_{(BR)}$	$I_R = 0.1\text{mA}$	100	-	-	V	
Reverse voltage leakage current	I_R	$V_R = 100\text{V}$	$T_j = 25^\circ\text{C}$	-	2.0	100	μA
			$T_j = 125^\circ\text{C}$	-	2.0	-	mA
Forward voltage	V_{F1}	$I_F = 3\text{A}$	$T_j = 25^\circ\text{C}$	-	0.71	-	V
			$T_j = 125^\circ\text{C}$	-	0.57	-	
	V_{F2}	$I_F = 5\text{A}$	$T_j = 25^\circ\text{C}$	-	0.77	0.85	
			$T_j = 125^\circ\text{C}$	-	0.63	-	

TYPICAL CHARACTERISTICS

FIG.1: FORWARD CURRENT DERATING CURVE

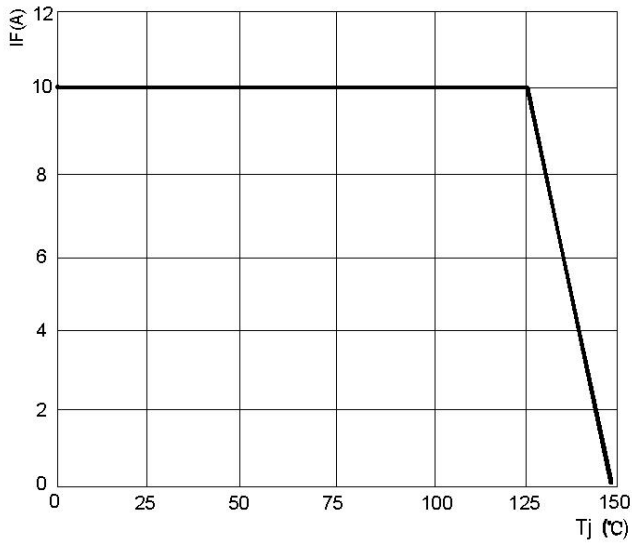

FIG.2: TYPICAL FORWARD CHARACTERISTICS

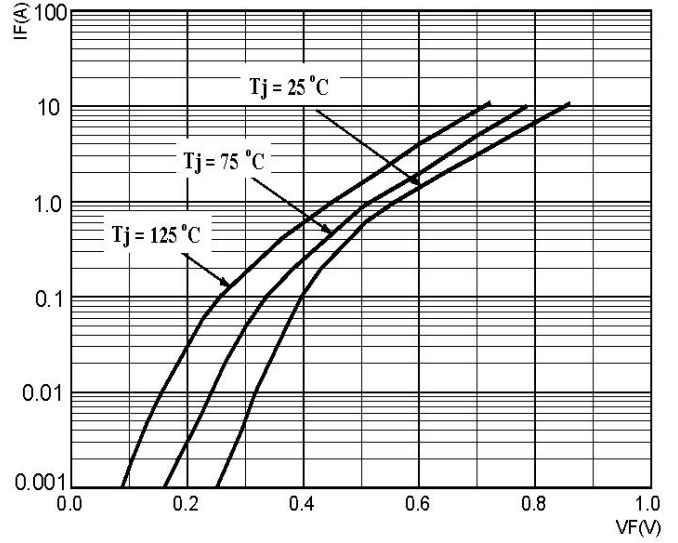

FIG.3: TOTAL CAPACITANCE DERATING CURVE

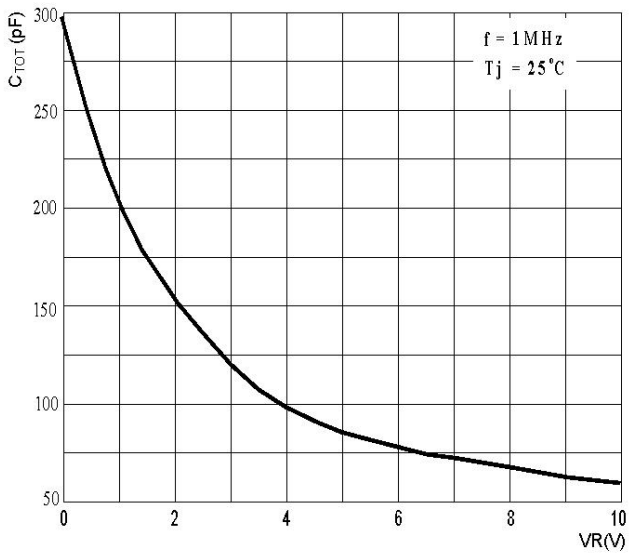
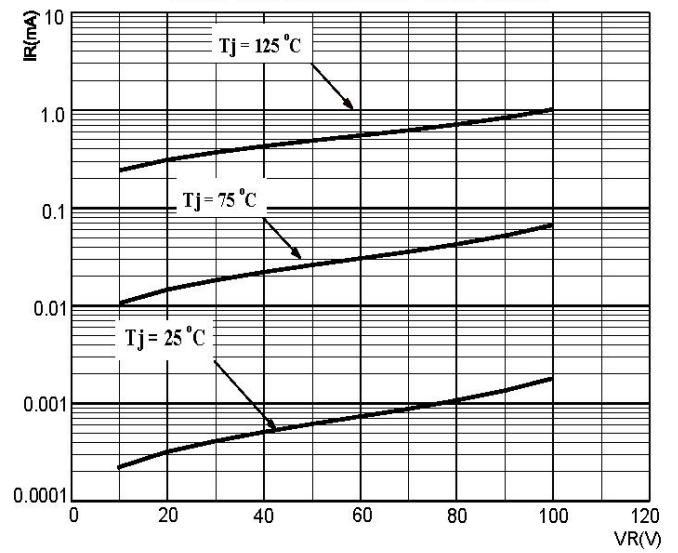
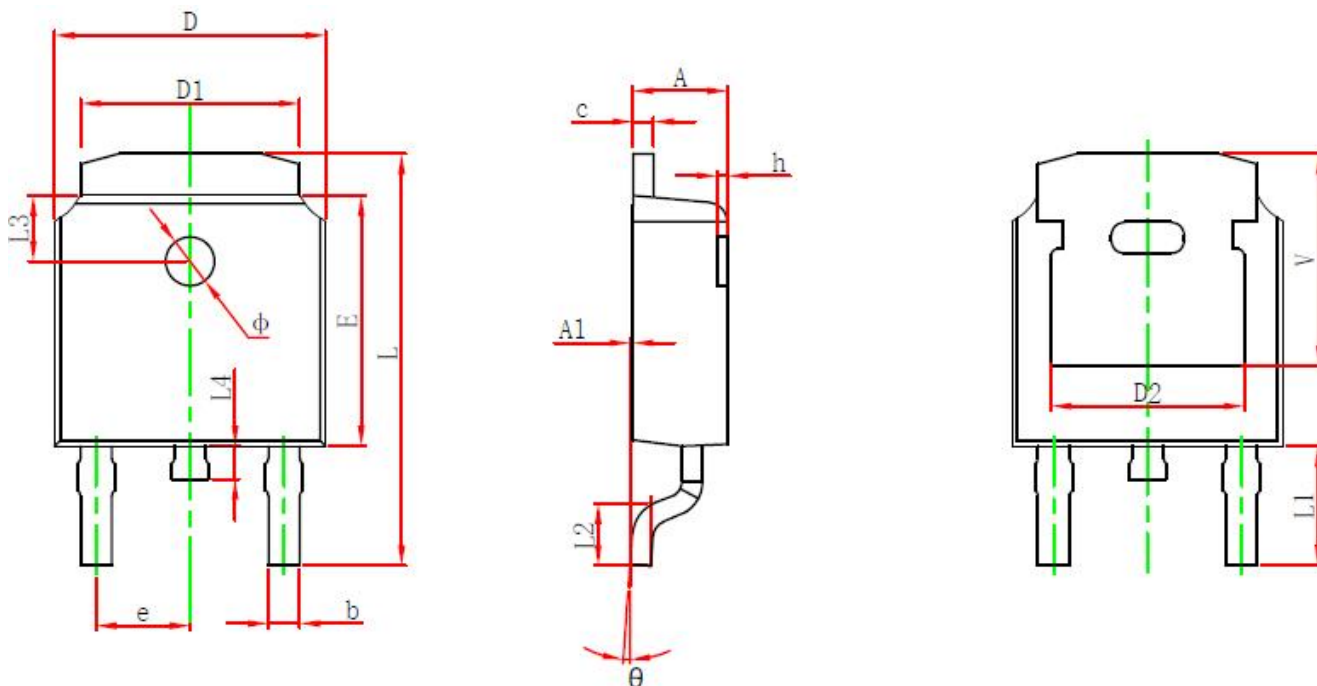

FIG.4: TYPICAL REVERSE CHARACTERISTICS



TO-252-2L PACKAGE OUTLINE DIMENSIONS



Symbol	Dimensions In Millimeters		Dimensions In Inches	
	Min.	Max.	Min.	Max.
A	2.200	2.400	0.087	0.094
A1	0.000	0.127	0.000	0.005
b	0.635	0.770	0.025	0.030
c	0.460	0.580	0.018	0.023
D	6.500	6.700	0.256	0.264
D1	5.100	5.460	0.201	0.215
D2	4.830 REF.		0.190 REF.	
E	6.000	6.200	0.236	0.244
e	2.186	2.386	0.086	0.094
L	9.712	10.312	0.382	0.406
L1	2.900 REF.		0.114 REF.	
L2	1.400	1.700	0.055	0.067
L3	1.600 REF.		0.063 REF.	
L4	0.600	1.000	0.024	0.039
φ	1.100	1.300	0.043	0.051
θ	0°	8°	0°	8°
h	0.000	0.300	0.000	0.012
V	5.250 REF.		0.207 REF.	

TO-252-2L SUGGESTED PAD LAYOUT

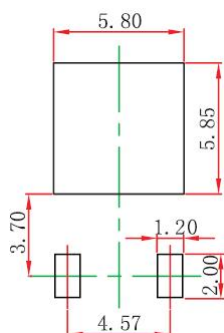

Note:

1. Controlling dimension in millimeters.
2. General tolerance: ±0.05mm.
3. The pad layout is for reference purpose only.

TO-252-2L TAPE AND REEL

TO-252 Embossed Carrier Tape

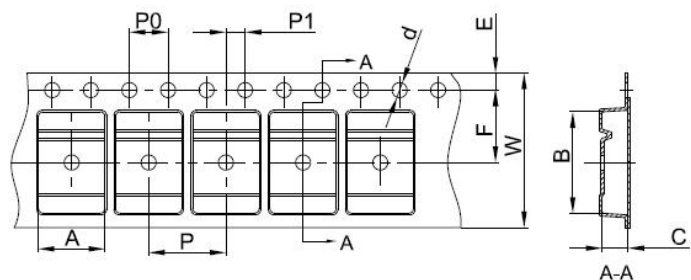

Packaging Description:

TO-252 parts are shipped in tape. The carrier tape is made from a dissipative (carbon filled) polycarbonate resin. The cover tape is a multilayer film (Heat Activated Adhesive in nature) primarily composed of polyester film, adhesive layer, sealant, and anti-static sprayed agent. These reeled parts in standard option are shipped with 25,00 units per 13" or 33.0 cm diameter reel. The reels are clear in color and is made of polystyrene plastic (anti-static coated).

Dimensions are in millimeter										
Pkg type	A	B	C	d	E	F	P0	P	P1	W
TO-252	6.90	10.50	2.70	Ø1.55	1.75	7.50	4.00	8.00	2.00	16.00

TO-252 Tape Leader and Trailer

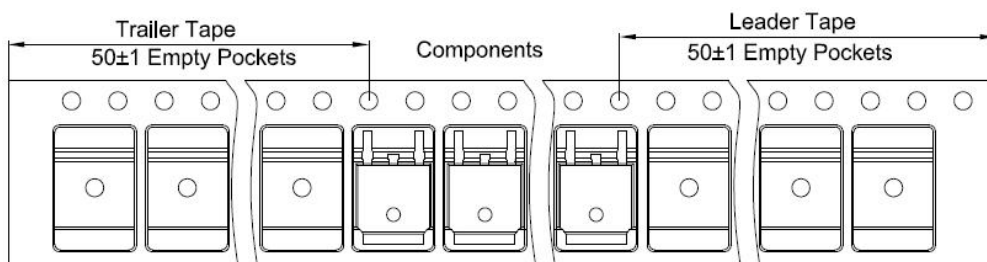

TO-252 Reel

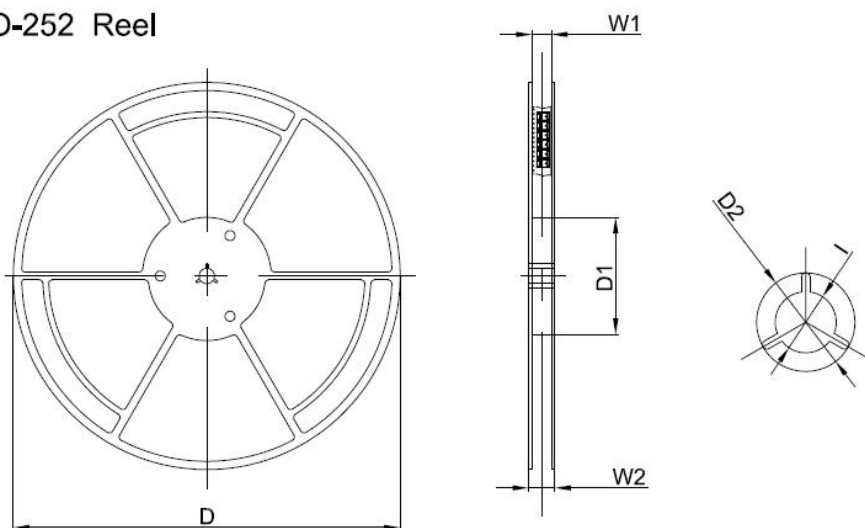

Dimensions are in millimeter						
Reel Option	D	D1	D2	W1	W2	l
13" Dia	330.00	100.00	Ø21.00	16.40	21.00	Ø13.00

REEL	Reel Size	Box	Box Slze(mm)	Carton	Carton Slze(mm)	G.W.(kg)
2,500 pcs	13Inch	2,500 pcs	340×336×29	25,000 pcs	353×346×365	

PUBLISHED BY**JIANGSU CHANGJING ELECTRONICS TECHNOLOGY CO., LTD.**

13th Floor, C Block, Tengfei Building, Yan Chuang Yuan, Nanjing Jiangbei New Area, China

LEGAL DISCLAIMER

The information given in this document shall in no event be regarded as a guarantee of conditions or characteristics. With respect to any examples, hints or typical values stated herein and/or any information regarding the application of the device, JSCJ hereby disclaims any and all warranties and liabilities of any kind, including without limitation, warranties of non-infringement of intellectual property rights of any third party.

In addition, any information given in this document is subject to customer's compliance with its obligations stated in this document and any applicable legal requirements, norms and standards concerning customer's products and any use of the product of JSCJ in customer's applications.

The data contained in this document is exclusively intended for technically trained staff. It is the responsibility of customer's technical departments to evaluate the suitability of the product for the intended application and the completeness of the product information given in this document with respect to such application.

INFORMATION

For further information on technology, delivery terms and conditions as well as prices, please contact your nearest JSCJ office (www.jscj-elec.com).

WARNINGS

Due to technical requirements, products may contain dangerous substances. For information on the types in question, please contact your nearest JSCJ office.

Except as otherwise explicitly approved by JSCJ in a written document signed by authorized representatives of JSCJ, JSCJ's products may not be used in any applications where a failure of the product or any consequences of the use thereof can reasonably be expected to result in personal injury.