

TO-220-3L Plastic-Encapsulate Voltage Regulator

CJ78M05 Three-terminal positive voltage regulator

FEATURES

- Maximum output current
 I_{OM} : 0.5 A
- Output voltage
 V_O : 5V
- Continuous total dissipation
 P_D : 1.5 W ($T_a=25^\circ\text{C}$)

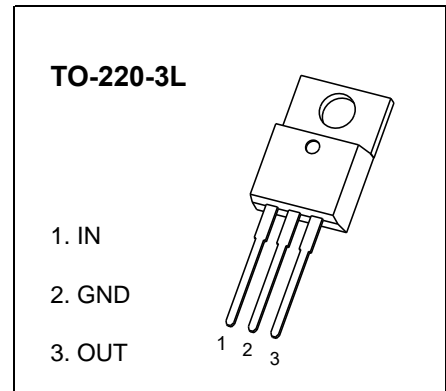

ABSOLUTE MAXIMUM RATINGS (Operating temperature range applies unless otherwise specified)

Parameter	Symbol	Value	Unit
Input Voltage	V_i	35	V
Thermal Resistance from Junction to Ambient	$R_{\theta JA}$	66.7	$^\circ\text{C/W}$
Operating Junction Temperature Range	T_{OPR}	-25~+125	$^\circ\text{C}$
Storage Temperature Range	T_{STG}	-65~+150	$^\circ\text{C}$

ELECTRICAL CHARACTERISTICS AT SPECIFIED VIRTUAL JUNCTION TEMPERATURE ($V_i=10\text{V}, I_o=350\text{mA}, C_i=0.33\mu\text{F}, C_o=0.1\mu\text{F}$, unless otherwise specified)

Parameter	Symbol	Test conditions	Min	Typ	Max	Unit
Output Voltage	V_o	25°C	4.8	5	5.2	V
		$7\text{V} \leq V_i \leq 20\text{V}, I_o=5\text{mA}-350\text{mA}$	-25~125 $^\circ\text{C}$	4.75	5	5.25
Load Regulation	ΔV_o	$I_o=5\text{mA}-0.5\text{A}$	25°C	15	100	mV
		$I_o=5\text{mA}-200\text{mA}$	25°C	5	50	mV
Line Regulation	ΔV_o	$7\text{V} \leq V_i \leq 25\text{V}, I_o=200\text{mA}$	25°C	3	100	mV
		$8\text{V} \leq V_i \leq 25\text{V}, I_o=200\text{mA}$	25°C	1	50	mV
Quiescent Current	I_q	25°C		4.2	6	mA
Quiescent Current Change	ΔI_q	$8\text{V} \leq V_i \leq 25\text{V}, I_o=200\text{mA}$	-25~125 $^\circ\text{C}$		0.8	mA
		$5\text{mA} \leq I_o \leq 350\text{mA}$	-25~125 $^\circ\text{C}$		0.5	mA
Output Noise Voltage	V_N	$10\text{Hz} \leq f \leq 100\text{KHz}$	25°C	40	200	$\mu\text{V}/V_o$
Ripple Rejection	RR	$8\text{V} \leq V_i \leq 18\text{V}, f=120\text{Hz}, I_o=300\text{mA}$	-25~125 $^\circ\text{C}$	62	80	dB
Dropout Voltage	V_d	$I_o=350\text{mA}$	25°C	2	2.5	V
Short Circuit Current	I_{sc}	$V_i=10\text{V}$	25°C	300		mA
Peak Current	I_{pk}	25°C		0.5		A

* Pulse test.

TYPICAL APPLICATION

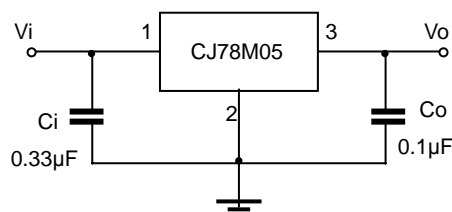

Note: Bypass capacitors are recommended for optimum stability and transient response and should be located as close as possible to the regulators.

Typical Characteristics

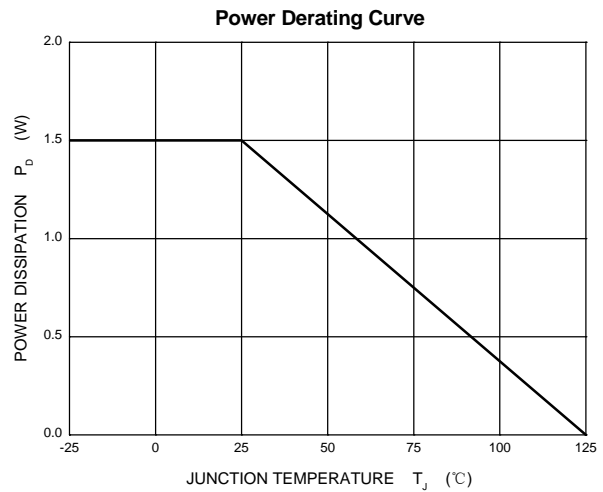
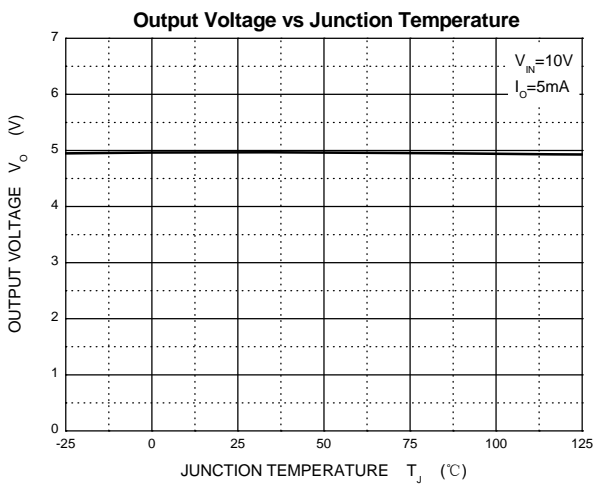
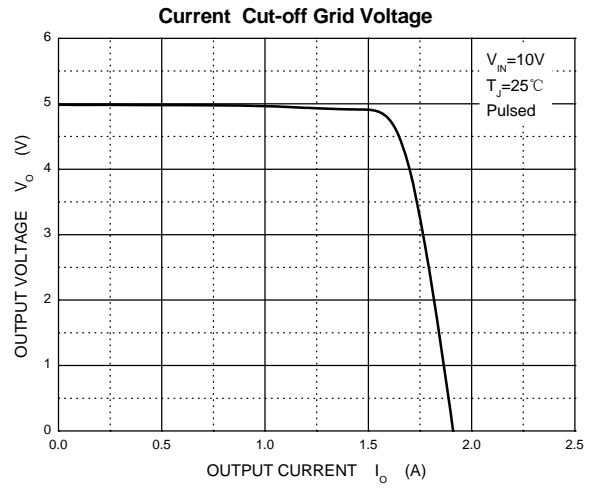
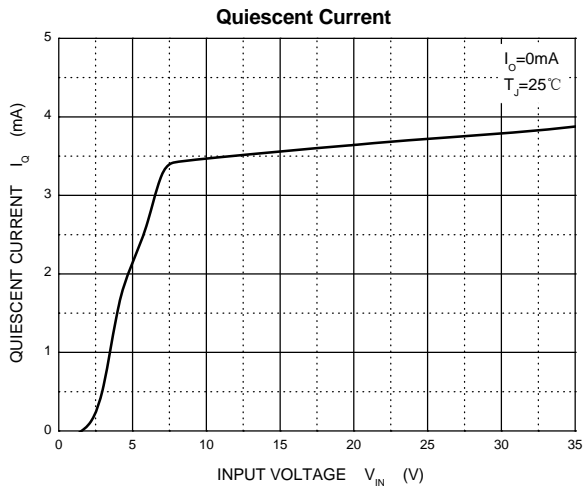
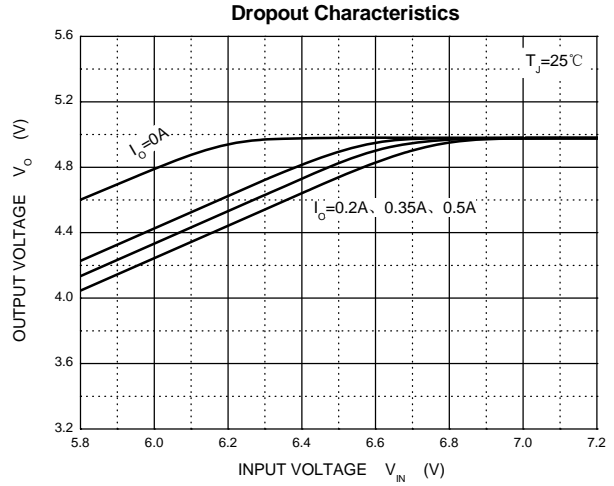
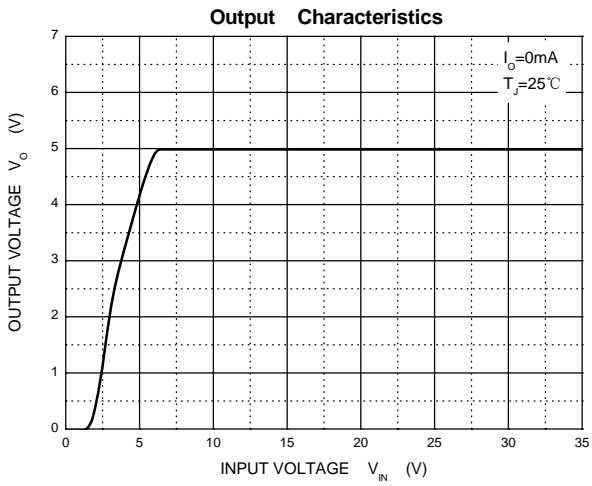

TO-220-3L Package Outline Dimensions

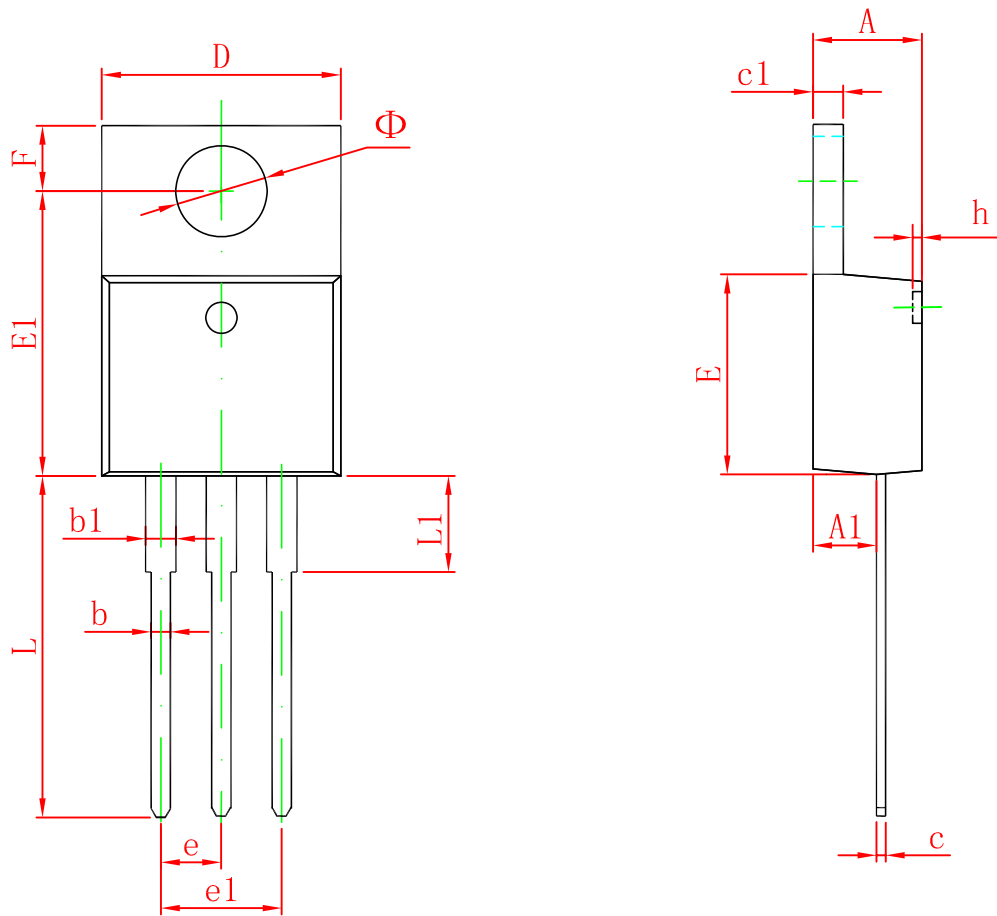

Symbol	Dimensions In Millimeters		Dimensions In Inches	
	Min	Max	Min	Max
A	4.470	4.670	0.176	0.184
A1	2.520	2.820	0.099	0.111
b	0.710	0.910	0.028	0.036
b1	1.170	1.370	0.046	0.054
c	0.310	0.530	0.012	0.021
c1	1.170	1.370	0.046	0.054
D	10.010	10.310	0.394	0.406
E	8.500	8.900	0.335	0.350
E1	12.060	12.460	0.475	0.491
e	2.540 TYP		0.100 TYP	
e1	4.980	5.180	0.196	0.204
F	2.590	2.890	0.102	0.114
h	0.000	0.300	0.000	0.012
L	13.400	13.800	0.528	0.543
L1	3.560	3.960	0.140	0.156
Φ	3.735	3.935	0.147	0.155