

-, \$ 1 \* 6 8 & + \$ 1 \* - , 1 \* ( / ( & 7 5 2 6 1 7 ( & + 1 2 / 2 \* < & 2 / 7 '  
\$ / 2 : ' 5 2 3 2 8 7 / , 1 ( \$ 5 5 ( \* 8 / \$ 7 2 5

### 6 & - \$ % ; ; ; \$

)( \$ 7 8 5 ( 6

- z Low Dropout Voltage: 1. V at A Output Current
- z Trimmed Current Limit
- z On-Chip Thermal Shutdown
- z Three-Terminal Adjustable or Fixed 91.8V, 2.5V, 3.3V, 5V
- z Operation Junction Temperature: to 125

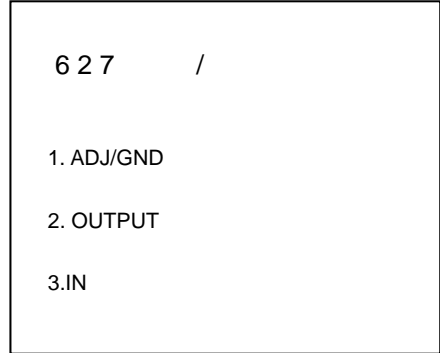

\*( 1 ( 5 \$ / ' ( 6 & 5 , 3 7 , 2 1

The 6CJA1117B-XXX \$ is a series of low dropout three-terminal regulators with a dropout of 1. V W \ \$ A output current.

The 6CJA1117B-XXX \$ series provides current limiting and thermal shutdown. Its circuit includes a trimmed bandage reference to assure output voltage accuracy to be within %. Current limit is trimmed to ensure specified. 2utput current and controlled short-circuit current. On-chip thermal shutdown provides protection against any combination of ambient temperature that would create excessive junction temperature.

The 6CJA1117B-XXX \$ has an adjustable version, that can provide the output voltage from 1.2 V to V with only 2 external resistors.

\$ 3 3 / , & \$ , 2 1 6

- z PC Motherboard
- z LCD Monitor
- z Graphic Card
- z DVD-Video Player
- z NIC/Switch
- z Telecom Modem
- z ADSL Modem
- z Printer and other peripheral Equipment

0 D U N L Q J

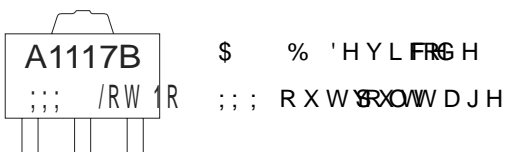

**ORDERING INFORMATION**

3DFNDJH	2SHUDWLQJ -XQFWLRQ	7HPSHUDWXUH	25DQJH
627 /	WR °C	6 & - \$	% '\$
		6 & - \$	% \$
		6 & - \$	% \$
		6 & - \$	% \$
		6 & - \$	% \$
		6 & - \$	% \$

**ABOSLUTE MAXIMUM RATINGS (T<sub>a</sub>=25°C unless otherwise noted)**

3DUDPHWHU	6\PERO	9DOXH	8QLW
,QSW 9ROWDJH	9 <sub>L</sub>		9
7KHUPDO 5HVLVWDQFH IURP -XQFWLRQ WR \$PELHQW			°C/W
2SHUDWLQJ 7HPSHUDWXUH	7 <sub>S</sub>	a	°C
2SHUDWLQJ 7HPSHUDWXUH	7 <sub>M</sub>	a	°C
6WRUDJH 7HPSHUDWXUH	7 <sub>VWJ</sub>	a	°C
/HDG 7HPSHUDWXUH 6ROGHULQJ	7 <sub>V</sub>		°C
(6' 5DWLQJ	+XPD\RG\ 0RGHO,		kV

1RWH 6WUHVHV JUHDWHU WKDQ WKRVH 5DVLVWDQFH XDGFDXVH SRXU  
 GDPDJH WR WKH GHYLFH 7KLV GHOVHURHQDWURKHGGIXQLFWLBOVDOKRIVWRU  
 FRQGLWLRQV EORFOWHGRXQGHU 35HFRPPHQGHGR2SHUDWLQJ & RSOL  
 WR 3\$EVROXWH QDM'XPU5HD[WHLHQGHG SHULRGV PD\ DIIHFW GHYLFH U

**RECOMMENDED OPERATING CONDITIONS**

,QSW 9ROWDJH	9 <sub>L</sub>		9
2SHUDWLQJ -XQFWLRQ	7HPSHUDWXUH	a	°C

( / ( & 7 5 , & \$ / & + \$ 5 \$ & 7 ( 5 , 6 7 , & 6

T<sub>J</sub>=25°C unless otherwise specified.

3DUDPHWHU	6\PERO	3DUW 12	7HW	FRQGLWLRQ	7\	OD	8QLW
5HIHUHQFH 9ROWDJH	6&-\$ % \$'- \$	287 P\$ .9 9 P\$ "287" \$ 9"9, 987 " 9					9
2XWSXW 9ROWDJH 9 <sub>2</sub>	6&-\$ % \$	287 P\$ .9 9 P\$ "287" \$ 9"9,1" 9					9
	6&-\$ % \$	287 P\$ .9 9 P\$ "287" \$ 9"9,1" 9					
	6&-\$ % \$	287 P\$ .9 9 P\$ "287" \$ 9"9,1" 9					
	6&-\$ % \$	287 P\$ .9 9 P\$ "287" \$ 9"9,1" 9					
	6&-\$ % \$	287 P\$ .9 9 P\$ "287" \$ 9"9,1" 9					
	6&-\$ % \$	287 P\$ .9 9 P\$ "287" \$ 9"9,1" 9					
/LQH 5HJXODWLRQ/15	6&-\$ % \$'- \$	287 P\$ 9"9,1 987 " 9					9
	6&-\$ % \$	287 P\$ 9"9,1 987 " 9					
	6&-\$ % \$	287 P\$ 9"9,1 987 " 9					
	6&-\$ % \$	287 P\$ 9"9,1 987 " 9					
	6&-\$ % \$	287 P\$ 9"9,1 987 " 9					
	6&-\$ % \$	287 P\$ 9"9,1 987 " 9					
/RDG 5HJXODWLRQ'5	6&-\$ % \$'- \$						P 9
	6&-\$ % \$						P 9
	6&-\$ % \$						
	6&-\$ % \$	9,1 987 9 P\$ "287" \$					
	6&-\$ % \$						
	6&-\$ % \$						
'URSRXW 9ROWDJH 9		287 \$					
\$GMXVW 3LQ & XUHHQW	6&-\$ % \$'- \$	9,1 9 287 P\$ 9,1 9 287 \$					\$ \$
\$GMFKDQJH	6&-\$ % \$'- \$	9,1 9 P\$ "287" \$					\$
0LQLPXP /RDG & XUHHQW	6&-\$ % \$'- \$						P\$
4XLHVFHQW & XUHHQW	6&-\$ % \$	9,1 9					P\$
	6&-\$ % \$	9,1 9					P\$
	6&-\$ % \$	9,1 9					P\$
	6&-\$ % \$	9,1 9					P\$
	6&-\$ % \$	9,1 9					P\$
	6&-\$ % \$	9,1 9					P\$
5LSSOH 5MHFWLRQ		I N+, & ) 9 287 ) 9 9,1 987 9 287 P\$					G %

: LW F B J V G D L WR FRSSHU DUHD RYHU EDFNVLGH JURXQ GDSODQRPRU :LWRHUQDCC  
! °C : GHSHQGLQJ RQ PRXQWLQJ WHFKQLTXH DQG WKH VLJH RI WKH FRSSHU DUHD

**FUNCTIONAL BLOCK DIAGRAM**

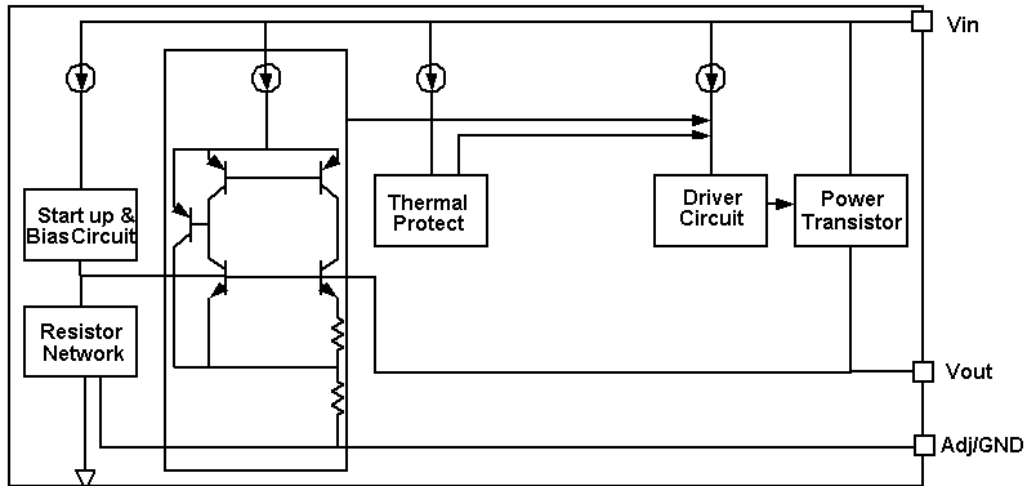

' ( 7 \$ , / ( ' ' ( 6 & 5 , 3 7 , 2 1

6 & - \$ % ; ; \$ D I V H U R H O R Q U R S Y R K O W W D K E W H H H U P U L Q D X O D W D P S L V O L F F L W E W D W L P S O K H  
 I L [ H Y H U V R R O H H G Z R D S D F D W B Y O Y G M X V W H D E L Q H H G Z R H V L D W B Y Z R D S D F W B R U W  
 L V R P S R R I V G P P I R G X Q G F O X G L D U F W U F S L L W U F E X L O G J M D S H U P K O V G S R Z Z H M U D Q V D Q B R V V  
 G U L F H W F X L W R Q Q G  
 7 K H V K H U P K O R Z P R G X G B I Q V V X F U K H S Q I G V S S O L F V D W W L Z R U N V D U H Z M H V Q M H X Q F W H L R S H U D W X U H  
 L D D U W H K D Q f &  
 7 K H E D Q G J P R S X S O U R Y L V G W D E I O I H U M R O M Z K J R W H H P S H U F R W H X L L H E F I R Q S H Q V E D F D H G G M O L J Q  
 F R Q V L G H U B W L H R Q S H U F R W H X L L H E X H C G M H U S S P f \$ Q O V K D F F X U F I R X W \$ R O W L D X H D U D Q B W H H G  
 W U L P M L F J K Q L T X H

7 < 3 , & \$ / \$ 3 3 / , & \$ 7 , 2 1

) L [ H G 2 X W S X W 9 R O W D J H 9 H U V L R Q

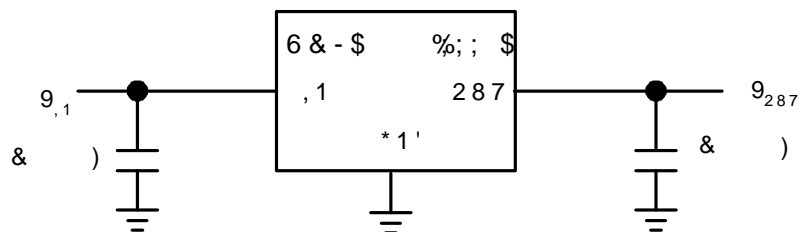

5 H F R P P H Q G X V L Q J X ) W D Q F D S D F L W R U D V E \ S D V V F D S D F L W R U & I R U D O O  
 5 H F R P P H Q G X V L Q J X ) W D Q F D S D F L W R U W R D V V X U H F L U F X L W V W D E L O L W \



# TYPICAL PERFORMANCE & + \$ 5 \$ & 7 ( 5 , 6 7 , & 6

TA 2 °C,

Vout Vs. Vin

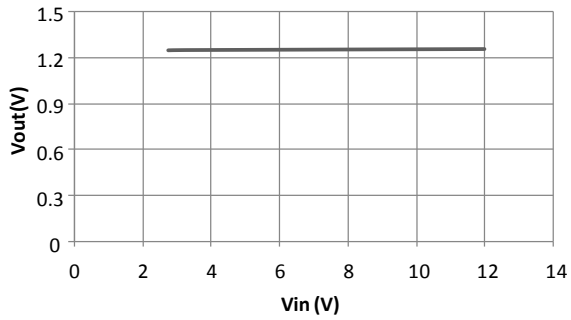

Dropout Vs. Iout

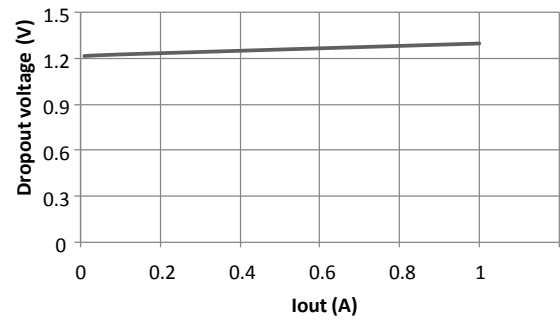

1.2

Load regulation

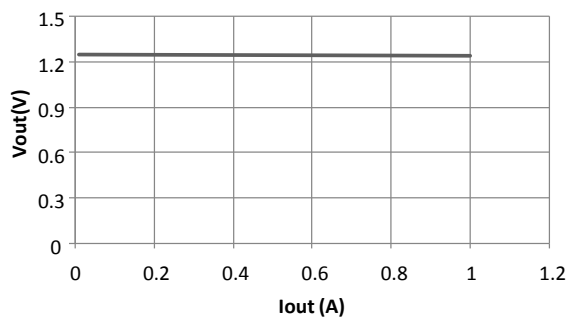

Thermal performance with OTP

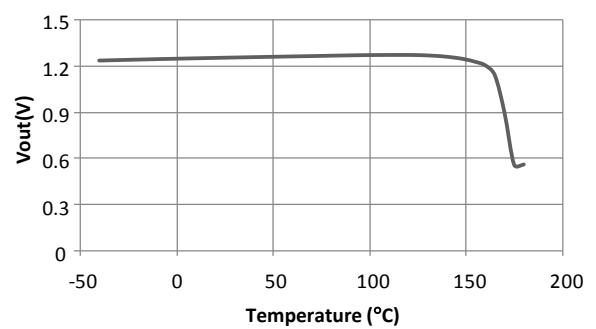

Power ON / OFF

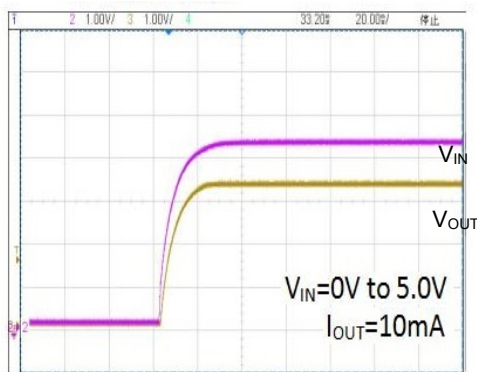

Power ON / OFF

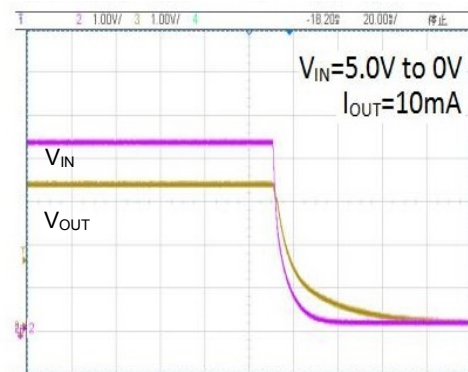

Load Transient Response

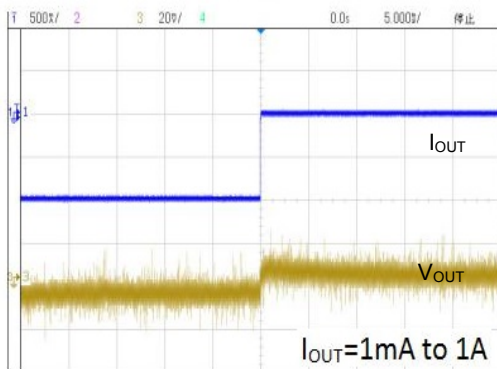

Load Transient Response

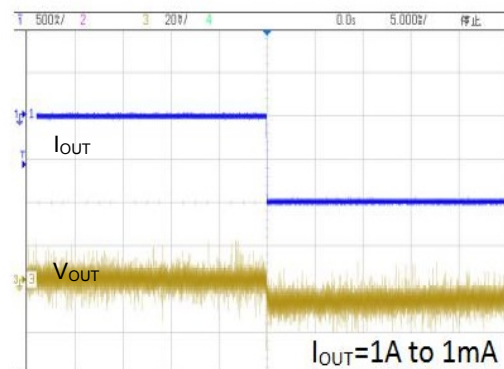

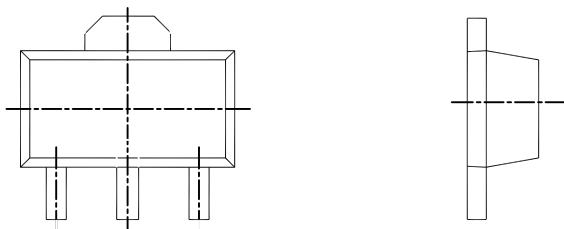

Symbol	Dimensions In Millimeters		Dimensions In Inches	
	Min	Max	Min	Max
A	1.400	1.600	0.055	0.063
b	0.320	0.520	0.013	0.020
b1	0.400	0.580	0.016	0.023
c	0.350	0.440	0.014	0.017
D	4.400	4.600	0.173	0.181
D1	1.550 REF.		0.061 REF.	
E	2.300	2.600	0.091	0.102
E1	3.940	4.250	0.155	0.167
e	1.500 TYP.		0.060 TYP.	
e1	3.000 TYP.		0.118 TYP.	
L	0.900	1.200	0.035	0.047

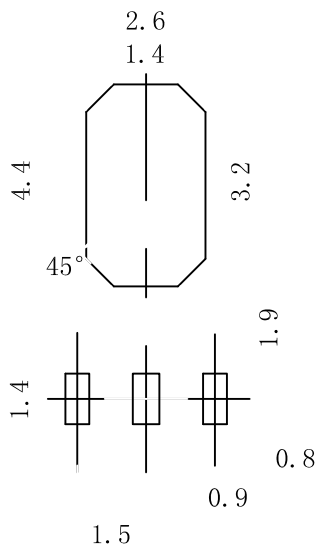

Note:  
 1. Controlling dimension: in millimeters.  
 2. General tolerance:  $\pm 0.05\text{mm}$ .  
 3. The pad layout is for reference purposes only.

SOT-89-3L Embossed Carrier Tape

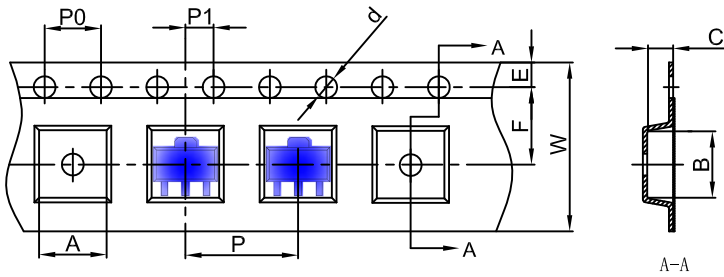

**Packaging Description:**  
 SOT-89-3L parts are shipped in tape. The carrier tape is made from a dissipative (carbon filled) polycarbonate resin. The cover tape is a multilayer film (Heat Activated Adhesive in nature) primarily composed of polyester film, adhesive layer, sealant, and anti-static sprayed agent. These reeled parts in standard option are shipped with 1,000 units per 7" or 18.0 cm diameter reel. The reels are clear in color and is made of polystyrene plastic (anti-static coated).

Dimensions are in millimeter										
Pkg type	A	B	C	d	E	F	P0	P	P1	W
SOT-89-3L	4.85	4.45	1.85	Ø1.50	1.75	5.50	4.00	8.00	2.00	12.00

SOT-89-3L Tape Leader and Trailer

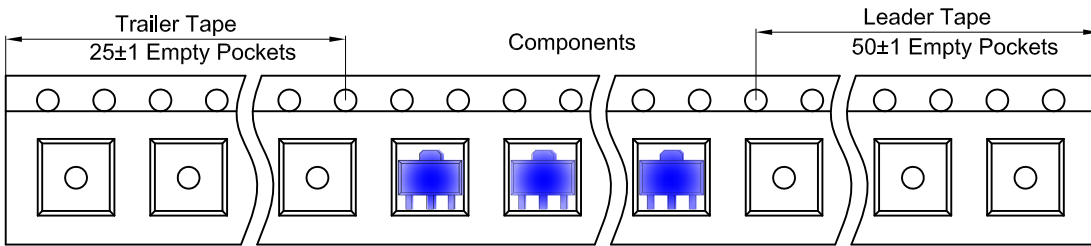

SOT-89-3L Reel

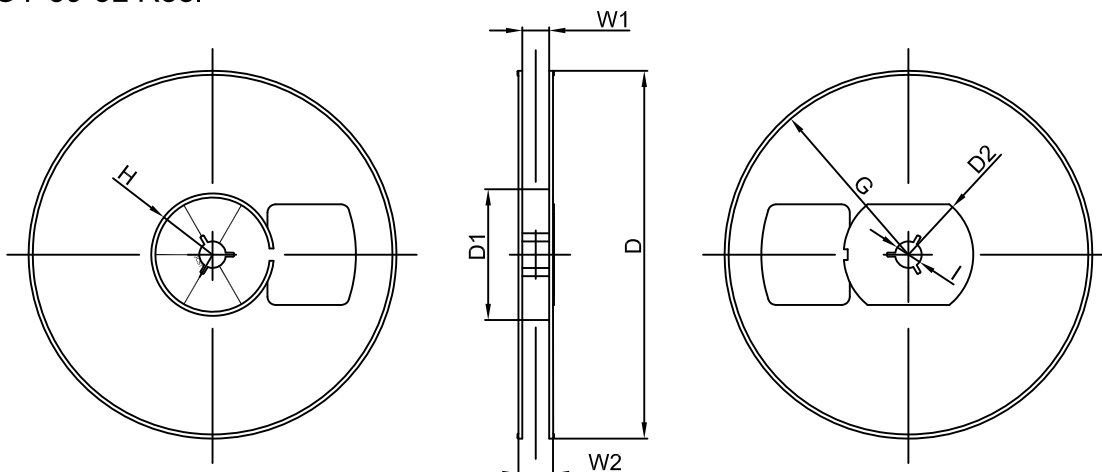

Dimensions are in millimeter								
Reel Option	D	D1	D2	G	H	I	W1	W2
7" Dia	Ø180.00	60.00	R32.00	R86.50	R30.00	Ø13.00	13.20	16.50

REEL	Reel Size	Box	Box Size(mm)	Carton	Carton Size(mm)	G.W.(kg)
1000 pcs	7 inch	10,000 pcs	203×203×195	40,000 pcs	438×438×220	