



TO-220-3L Plastic-Encapsulate Transistors

TIP120,121,122 Darlington TRANSISTOR (NPN)

TIP125,126,127 Darlington TRANSISTOR (PNP)

FEATURES

- Medium Power Complementary Silicon Transistors

MAXIMUM RATINGS (T_a=25°C unless otherwise noted)

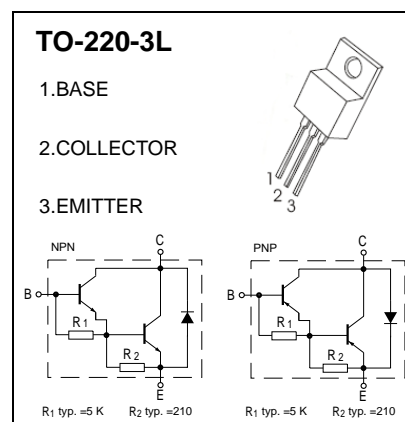

Symbol	Parameter	TIP120 TIP125	TIP121 TIP126	TIP122 TIP127	Unit
V _{CBO}	Collector-Base Voltage	60	80	100	V
V _{CEO}	Collector-Emitter Voltage	60	80	100	V
V _{EBO}	Emitter-Base Voltage	5			V
I _C	Collector Current -Continuous	5			A
P _C	Collector Power Dissipation	2			W
R _{JA}	Thermal Resistance Junction to Ambient	62.5			°C/W
R _{Jc}	Thermal Resistance Junction to Case	1.92			°C/W
T _J , T _{stg}	Operation Junction and Storage Temperature Range	-55to+150			°C

ELECTRICAL CHARACTERISTICS (T_a=25°C unless otherwise specified)

Parameter	Symbol	Test conditions	Min	Max	Unit
Collector-base breakdown voltage TIP120,TIP125 TIP121,TIP126 TIP122,TIP127	V _{(BR)CBO}	I _C = 1mA, I _E =0	60 80 100		V
Collector-emitter breakdown voltage TIP120,TIP125 TIP121,TIP126 TIP122,TIP127	V _{CEO(SUS)}	I _C = 30mA, I _B =0	60 80 100		V
Collector cut-off current TIP120,TIP125 TIP121,TIP126 TIP122,TIP127	I _{CBO}	V _{CB} = 60 V, I _E =0 V _{CB} = 80 V, I _E =0 V _{CB} = 100V, I _E =0		0.2	mA
Collector cut-off current TIP120,TIP125 TIP121,TIP126 TIP122,TIP127	I _{CEO}	V _{CE} =30 V, I _B =0 V _{CE} =40 V, I _B =0 V _{CE} =50 V, I _B =0		0.5	mA
Emitter cut-off current	I _{EBO}	V _{EB} =5 V, I _C =0		2	mA
DC current gain	h _{FE(1)}	V _{CE} = 3V, I _C =0.5A	1000		
	h _{FE(2)}	V _{CE} = 3V, I _C =3 A	1000	12000	
Collector-emitter saturation voltage	V _{CE(sat)}	I _C =3A, I _B =12mA I _C =5 A, I _B =20mA		2 4	V
Base-emitter voltage	V _{BE}	V _{CE} =3V, I _C =3 A		2.5	V
Output Capacitance TIP125,TIP126,TIP127 TIP120,TIP121,TIP122	C _{ob}	V _{CB} =10V, I _E =0, f=0.1MHz		300 200	pF

Typical Characteristics

TIP122

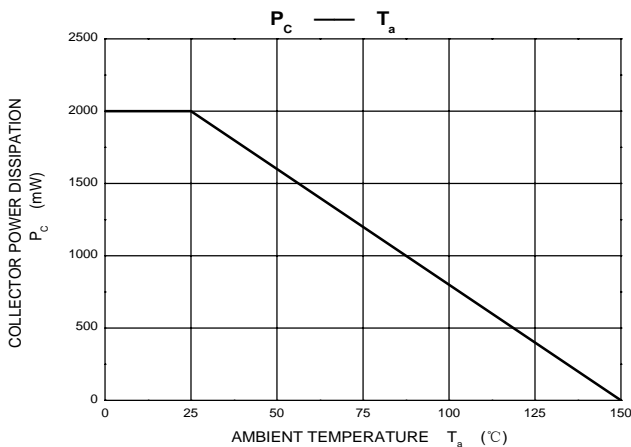
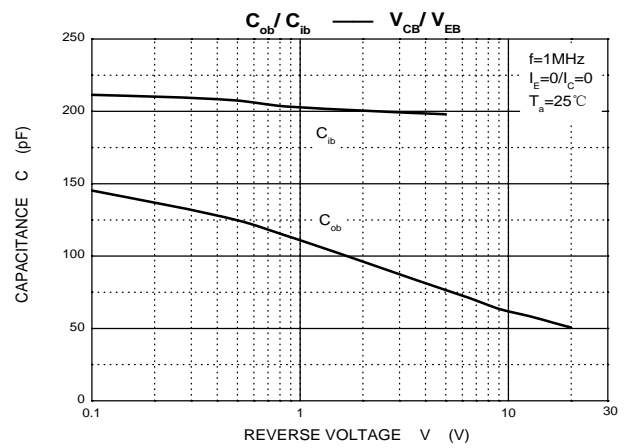
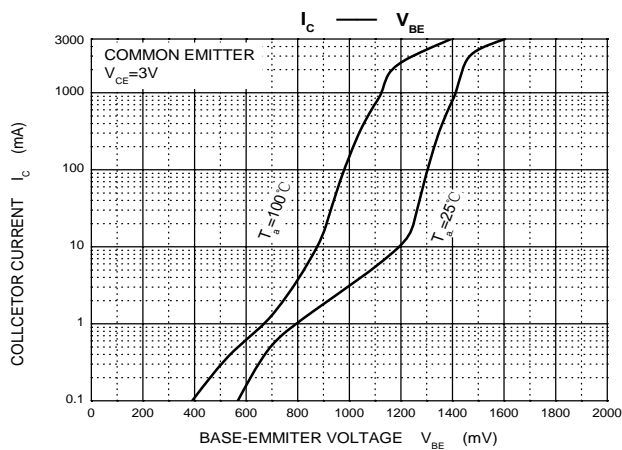
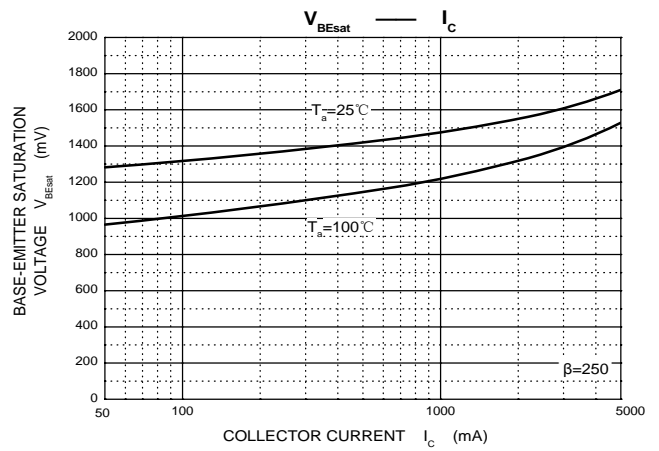
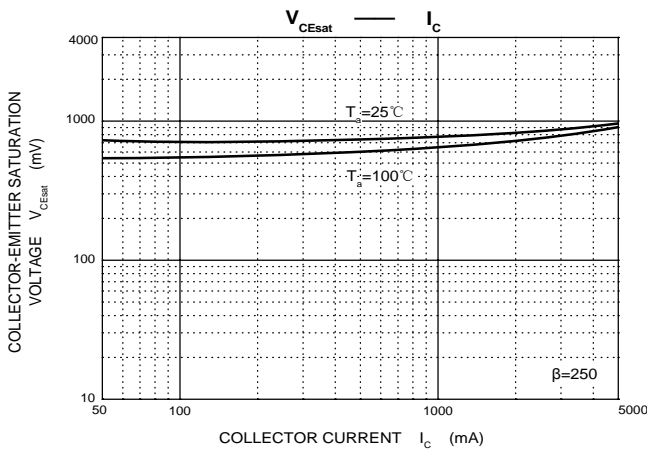
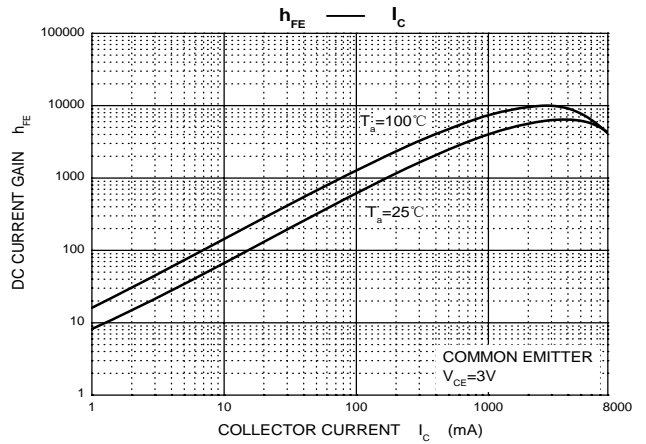
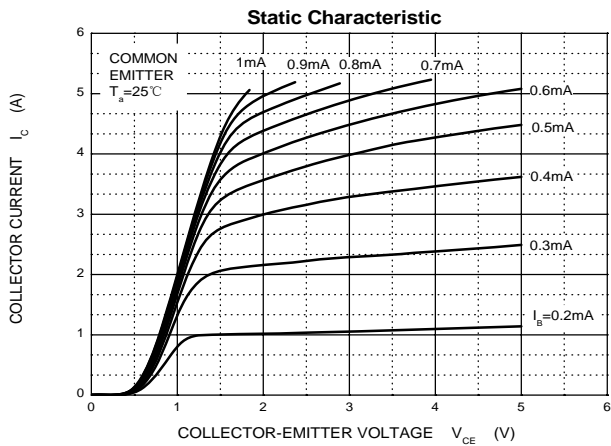

TO-220-3L Package Outline Dimensions

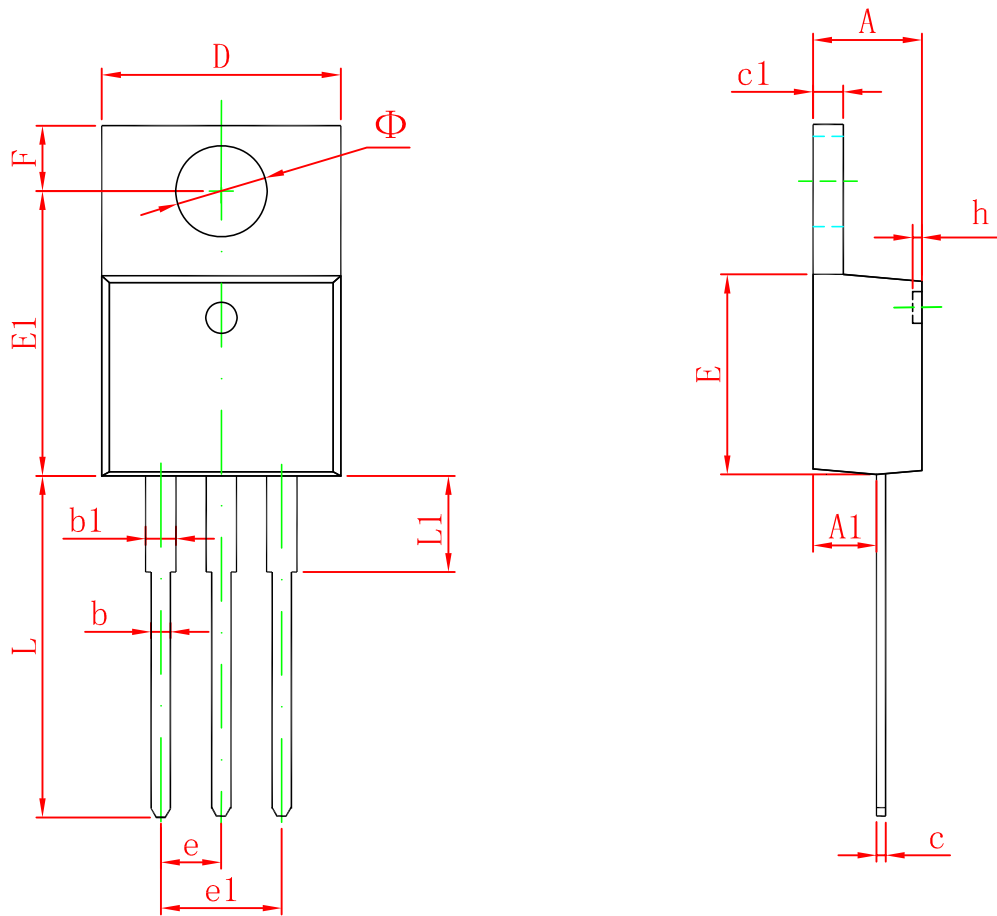

Symbol	Dimensions In Millimeters		Dimensions In Inches	
	Min	Max	Min	Max
A	4.470	4.670	0.176	0.184
A1	2.520	2.820	0.099	0.111
b	0.710	0.910	0.028	0.036
b1	1.170	1.370	0.046	0.054
c	0.310	0.530	0.012	0.021
c1	1.170	1.370	0.046	0.054
D	10.010	10.310	0.394	0.406
E	8.500	8.900	0.335	0.350
E1	12.060	12.460	0.475	0.491
e	2.540 TYP		0.100 TYP	
e1	4.980	5.180	0.196	0.204
F	2.590	2.890	0.102	0.114
h	0.000	0.300	0.000	0.012
L	13.400	13.800	0.528	0.543
L1	3.560	3.960	0.140	0.156
Φ	3.735	3.935	0.147	0.155