

TO-126 Plastic-Encapsulate Transistors

TIP122 Darlington Transistor (NPN)

TIP127 Darlington Transistor (PNP)

FEATURES

- Medium Power Complementary Silicon Transistors

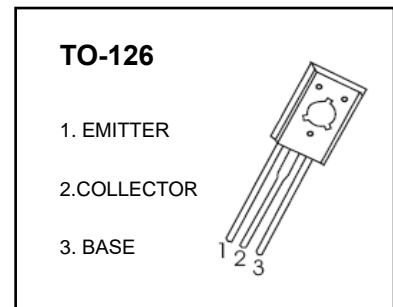

MARKING

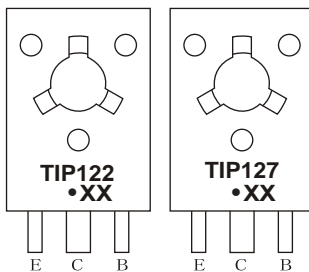

TIP122, TIP127=Device code
Solid dot = Green molding compound device, if none, the normal device
XX=Code

Equivalent Circuit

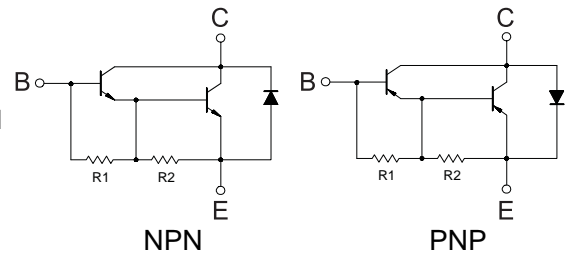

R1 typ. =5 K R2 typ. =210

R1 typ. =5 K R2 typ. =210

ORDERING INFORMATION

Part Number	Package	Packing Method	Pack Quantity
TIP122	TO-126	Bulk	200pcs/Bag
TIP127	TO-126	Bulk	200pcs/Bag
TIP122-TU	TO-126	Tube	60pcs/Tube
TIP127-TU	TO-126	Tube	60pcs/Tube

MAXIMUM RATINGS (T_a=25°C unless otherwise noted)

Symbol	Parameter	TIP122	TIP127	Unit
V _{CBO}	Collector-Base Voltage	100	-100	V
V _{CEO}	Collector-Emitter Voltage	100	-100	V
V _{EBO}	Emitter-Base Voltage	5	-5	V
I _C	Collector Current -Continuous	5	-5	A
P _C *	Collector Power Dissipation	1.25		W
R _{θJA}	Thermal Resistance Junction to Ambient	100		°C/W
R _{θJC}	Thermal Resistance Junction to Case	8.33		°C/W
T _J , T _{stg}	Operation Junction and Storage Temperature Range	-55~+150		°C

ELECTRICAL CHARACTERISTICS

$T_a=25^\circ\text{C}$ unless otherwise specified

TIP122					NPN
Parameter	Symbol	Test conditions	Min	Max	Unit
Collector-base breakdown voltage	$V_{(BR)CBO}$	$I_C=1\text{mA}, I_E=0$	100		V
Collector-emitter breakdown voltage	$V_{CEO(SUS)}$	$I_C=30\text{mA}, I_B=0$	100		V
Collector cut-off current	I_{CBO}	$V_{CB}=100\text{V}, I_E=0$		0.2	mA
Collector cut-off current	I_{CEO}	$V_{CE}=50\text{V}, I_B=0$		0.5	mA
Emitter cut-off current	I_{EBO}	$V_{EB}=5\text{V}, I_C=0$		2	mA
DC current gain	$h_{FE(1)}$	$V_{CE}=3\text{V}, I_C=0.5\text{A}$	1000		
	$h_{FE(2)}$	$V_{CE}=3\text{V}, I_C=3\text{A}$	1000	12000	
Collector-emitter saturation voltage	$V_{CE(sat)}$	$I_C=3\text{A}, I_B=12\text{mA}$		2	V
		$I_C=5\text{A}, I_B=20\text{mA}$		4	
Base-emitter voltage	V_{BE}	$V_{CE}=3\text{V}, I_C=3\text{A}$		2.5	V
Output Capacitance	C_{ob}	$V_{CB}=10\text{V}, I_E=0, f=0.1\text{MHz}$		200	pF

TIP127					PNP
Parameter	Symbol	Test conditions	Min	Max	Unit
Collector-base breakdown voltage	$V_{(BR)CBO}$	$I_C=-1\text{mA}, I_E=0$	-100		V
Collector-emitter breakdown voltage	$V_{CEO(SUS)}$	$I_C=-30\text{mA}, I_B=0$	-100		V
Collector cut-off current	I_{CBO}	$V_{CB}=-100\text{V}, I_E=0$		-0.2	mA
Collector cut-off current	I_{CEO}	$V_{CE}=-50\text{V}, I_B=0$		-0.5	mA
Emitter cut-off current	I_{EBO}	$V_{EB}=-5\text{V}, I_C=0$		-2	mA
DC current gain	$h_{FE(1)}$	$V_{CE}=-3\text{V}, I_C=-0.5\text{A}$	1000		
	$h_{FE(2)}$	$V_{CE}=-3\text{V}, I_C=-3\text{A}$	1000	12000	
Collector-emitter saturation voltage	$V_{CE(sat)}$	$I_C=-3\text{A}, I_B=-12\text{mA}$		-2	V
		$I_C=-5\text{A}, I_B=-20\text{mA}$		-4	
Base-emitter voltage	V_{BE}	$V_{CE}=-3\text{V}, I_C=-3\text{A}$		-2.5	V
Output Capacitance	C_{ob}	$V_{CB}=-10\text{V}, I_E=0, f=0.1\text{MHz}$		300	pF

* This test is performed with no heat sink at $T_a=25^\circ\text{C}$.

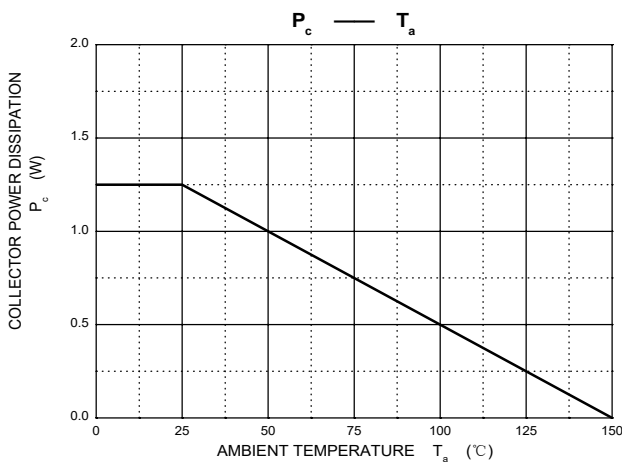
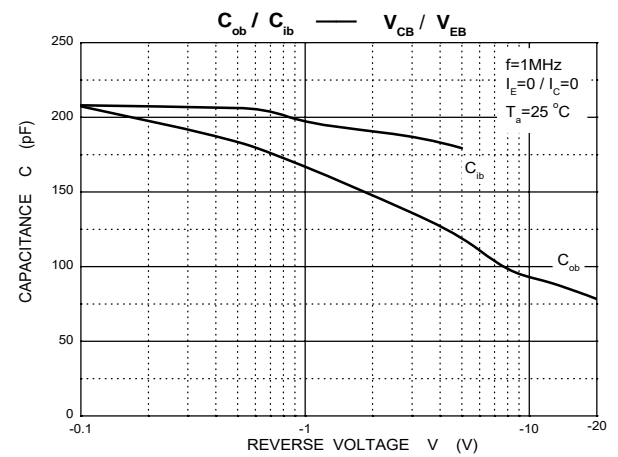
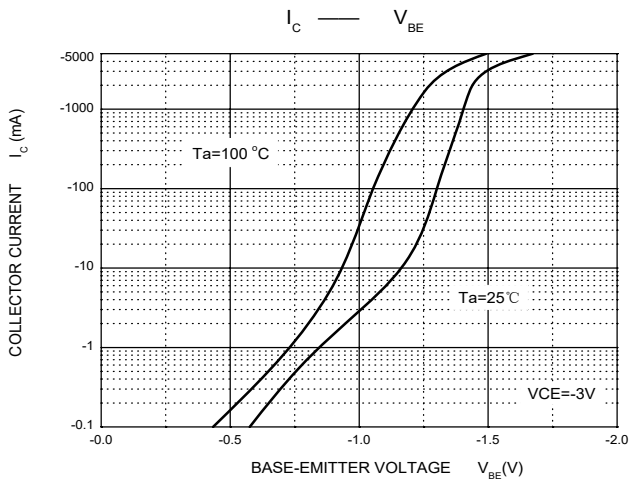
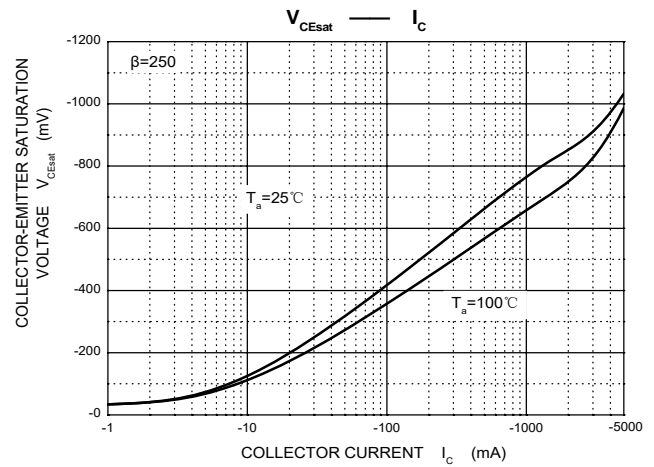
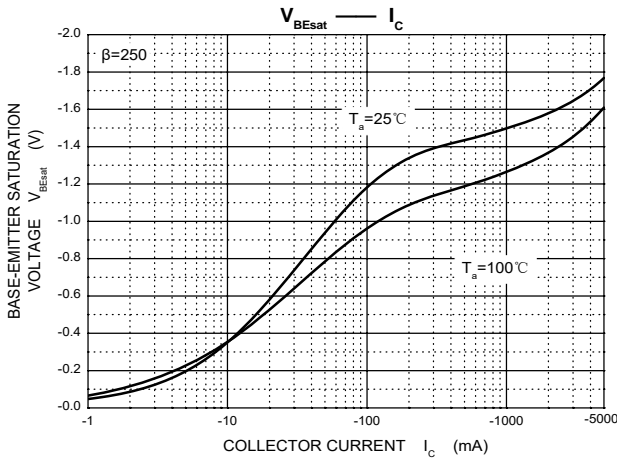
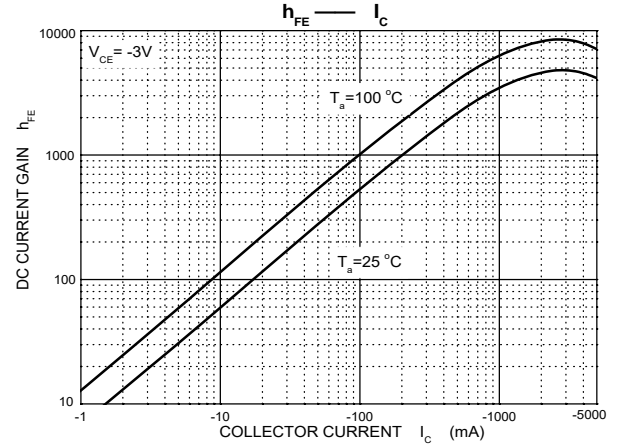
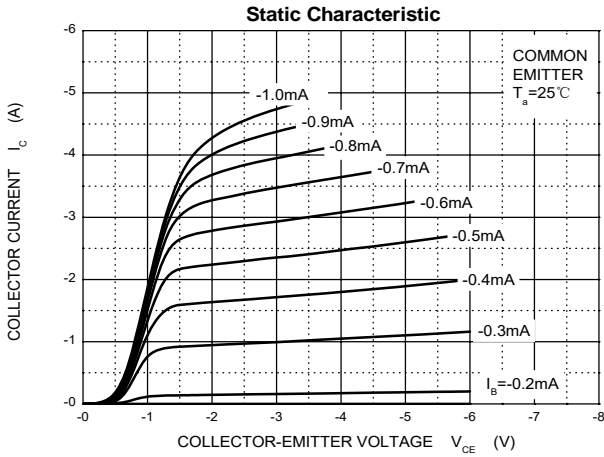

TO-126 Package Outline Dimensions

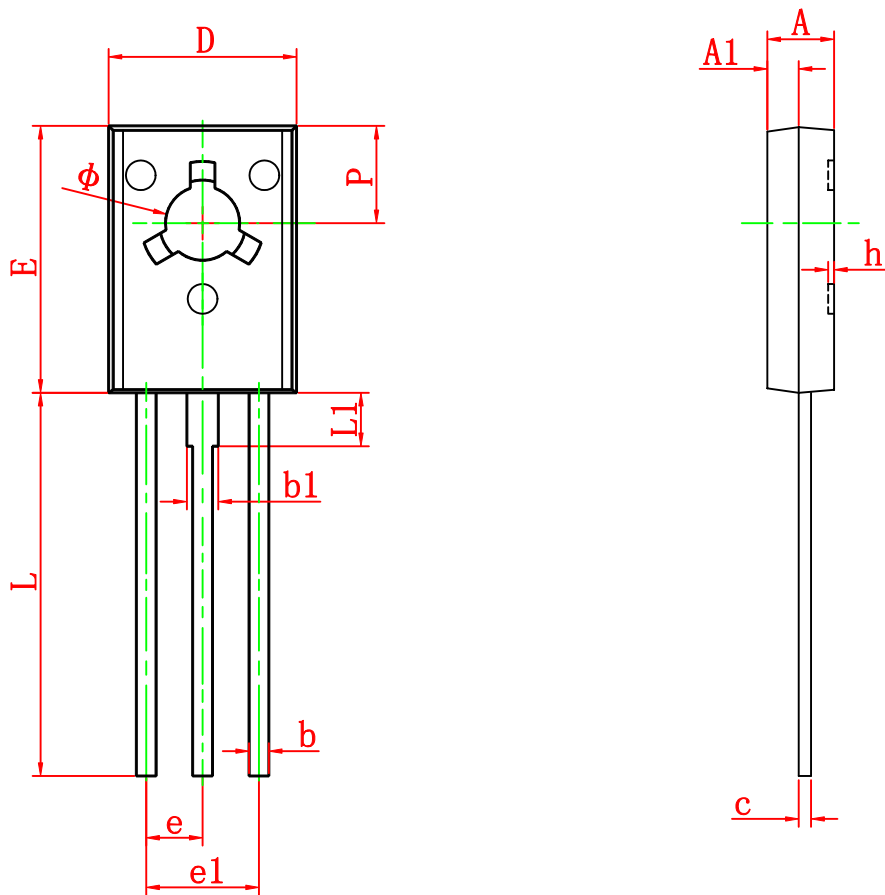

Symbol	Dimensions In Millimeters		Dimensions In Inches	
	Min	Max	Min	Max
A	2.500	2.900	0.098	0.114
A1	1.100	1.500	0.043	0.059
b	0.660	0.860	0.026	0.034
b1	1.170	1.370	0.046	0.054
c	0.450	0.600	0.018	0.024
D	7.400	7.800	0.291	0.307
E	10.600	11.000	0.417	0.433
e	2.290 TYP		0.090 TYP	
e1	4.480	4.680	0.176	0.184
h	0.000	0.300	0.000	0.012
L	15.300	15.700	0.602	0.618
L1	2.100	2.300	0.083	0.091
P	3.900	4.100	0.154	0.161
Φ	3.000	3.200	0.118	0.126