



SOT-363 Power management Dual-transistors

UMZ1N DUAL TRANSISTOR (NPN+PNP)

DESCRIPTION

Silicon epitaxial planar transistor

FEATURES

- 2SA1037AK and 2SC2412K are housed independently in a package
- Transistor elements independent, eliminating interference
- Mounting cost and area can be cut in half

MARKING: Z1

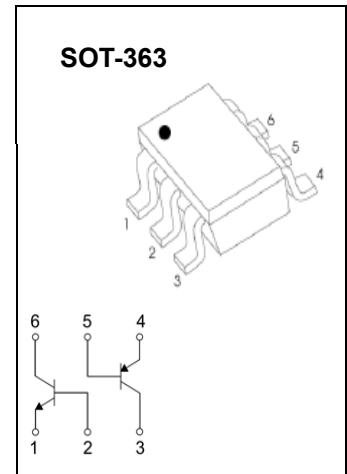
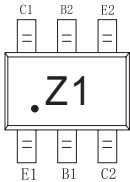

TR1 MAXIMUM RATINGS $T_a=25^{\circ}\text{C}$ unless otherwise noted

Symbol	Parameter	Value	Unit
V_{CBO}	Collector- Base Voltage	60	V
V_{CEO}	Collector-Emitter Voltage	50	V
V_{EBO}	Emitter-Base Voltage	7	V
I_c	Collector Current -Continuous	0.15	A
P_C	Collector Power Dissipation	0.15	W
T_{stg}	Operation Junction and Storage Temperature Range	-55~+150	$^{\circ}\text{C}$

TR2 MAXIMUM RATINGS $T_a=25^{\circ}\text{C}$ unless otherwise noted

Symbol	Parameter	Value	Unit
V_{CBO}	Collector- Base Voltage	-60	V
V_{CEO}	Collector-Emitter Voltage	-50	V
V_{EBO}	Emitter-Base Voltage	-6	V
I_c	Collector Current -Continuous	-0.15	A
P_C	Collector Power Dissipation	0.15	W
T_{stg}	Operation Junction and Storage Temperature Range	-55~+150	$^{\circ}\text{C}$

TR1 NPN ELECTRICAL CHARACTERISTICS (Ta=25°C unless otherwise specified)

Parameter	Symbol	Test conditions	Min	Typ	Max	Unit
Collector-base breakdown voltage	$V_{(BR)CBO}$	$I_C=50\mu A, I_E=0$	60			V
Collector-emitter breakdown voltage	$V_{(BR)CEO}$	$I_C=1mA, I_B=0$	50			V
Emitter-base breakdown voltage	$V_{(BR)EBO}$	$I_E=50\mu A, I_C=0$	7			V
Collector cut-off current	I_{CBO}	$V_{CB}=60V, I_E=0$			0.1	μA
Emitter cut-off current	I_{EBO}	$V_{EB}=7V, I_C=0$			0.1	μA
DC current gain	h_{FE}	$V_{CE}=6V, I_C=1mA$	120		560	
Collector-emitter saturation voltage	$V_{CE(sat)}$	$I_C=50mA, I_B=5mA$			0.4	V
Transition frequency	f_T	$V_{CE}=12V, I_C=2mA, f=100MHz$		180		MHz
Collector output capacitance	C_{ob}	$V_{CB}=12V, I_E=0, f=1MHz$		2.0	3.5	pF

TR1 PNP ELECTRICAL CHARACTERISTICS (Ta=25°C unless otherwise specified)

Parameter	Symbol	Test conditions	Min	Typ	Max	Unit
Collector-base breakdown voltage	$V_{(BR)CBO}$	$I_C=-50\mu A, I_E=0$	-60			V
Collector-emitter breakdown voltage	$V_{(BR)CEO}$	$I_C=-1mA, I_B=0$	-50			V
Emitter-base breakdown voltage	$V_{(BR)EBO}$	$I_E=-50\mu A, I_C=0$	-6			V
Collector cut-off current	I_{CBO}	$V_{CB}=-60V, I_E=0$			-0.1	μA
Emitter cut-off current	I_{EBO}	$V_{EB}=-6V, I_C=0$			-0.1	μA
DC current gain	h_{FE}	$V_{CE}=-6V, I_C=-1mA$	120		560	
Collector-emitter saturation voltage	$V_{CE(sat)}$	$I_C=-50mA, I_B=-5mA$			-0.5	V
Transition frequency	f_T	$V_{CE}=-12V, I_C=-2mA, f=100MHz$		140		MHz
Collector output capacitance	C_{ob}	$V_{CB}=-12V, I_E=0, f=1MHz$			5	pF

SOT-363 Package Outline Dimensions

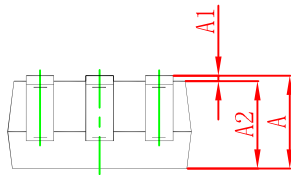
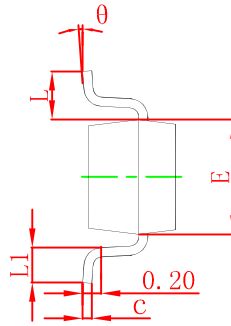

Symbol	Dimensions In Millimeters		Dimensions In Inches	
	Min	Max	Min	Max
A	0.900	1.100	0.035	0.043
A1	0.000	0.100	0.000	0.004
A2	0.900	1.000	0.035	0.039
b	0.150	0.350	0.006	0.014
c	0.100	0.150	0.004	0.006
D	2.000	2.200	0.079	0.087
E	1.150	1.350	0.045	0.053
E1	2.150	2.400	0.085	0.094
e	0.650 TYP		0.026 TYP	
e1	1.200	1.400	0.047	0.055
L	0.525 REF		0.021 REF	
L1	0.260	0.460	0.010	0.018
theta	0°	8°	0°	8°

SOT-363 Suggested Pad Layout



Note:

1. Controlling dimension: in millimeters.
2. General tolerance: $\pm 0.05\text{mm}$.
3. The pad layout is for reference purposes only.

NOTICE

JSCJ reserves the right to make modifications, enhancements, improvements, corrections or other changes without further notice to any product herein. JSCJ does not assume any liability arising out of the application or use of any product described herein.

SOT-363 Tape and Reel

SOT-363 Embossed Carrier Tape

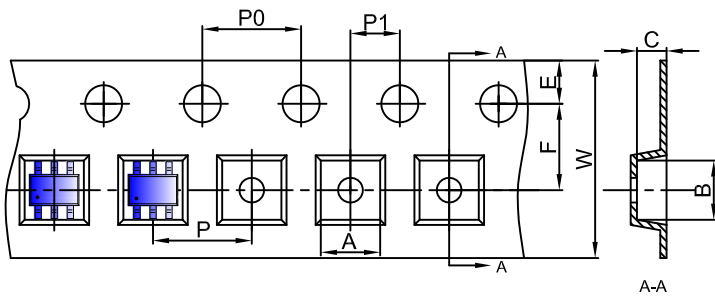

Packaging Description:

SOT-363 parts are shipped in tape. The carrier tape is made from a dissipative (carbon filled) polycarbonate resin. The cover tape is a multilayer film (Heat Activated Adhesive in nature) primarily composed of polyester film, adhesive layer, sealant, and anti-static sprayed agent. These reeled parts in standard option are shipped with 3,000 units per 7" or 17.8cm diameter reel. The reels are clear in color and is made of polystyrene plastic (anti-static coated).

Dimensions are in millimeter										
Pkg type	A	B	C	d	E	F	P0	P	P1	W
SOT-363	2.25	2.55	1.20	Ø1.50	1.75	3.50	4.00	4.00	2.00	8.00

SOT-363 Tape Leader and Trailer

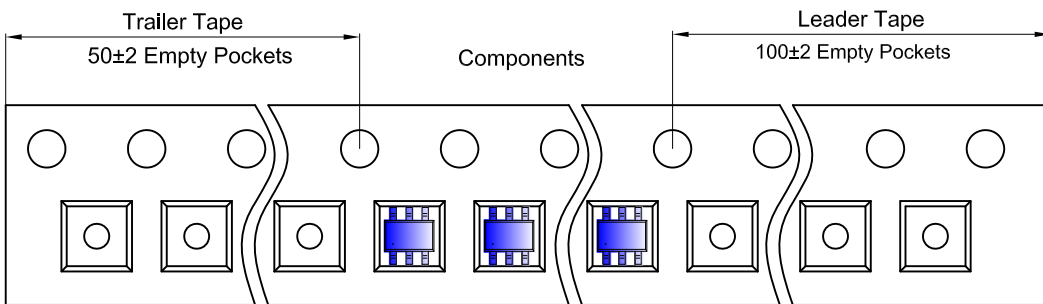

SOT-363 Reel

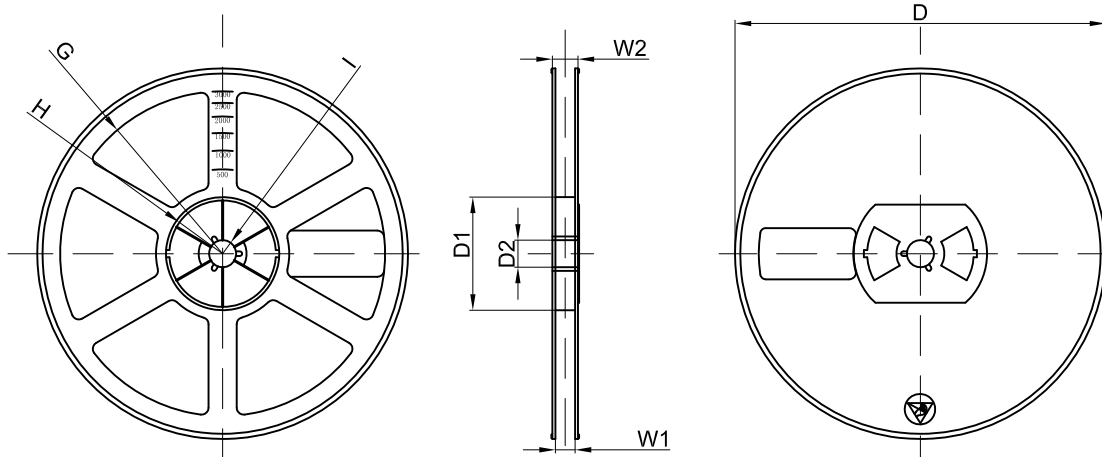

Dimensions are in millimeter								
Reel Option	D	D1	D2	G	H	I	W1	W2
7" Dia	Ø178.00	54.40	13.00	R78.00	R25.60	R6.50	9.50	12.30

REEL	Reel Size	Box	Box Size(mm)	Carton	Carton Size(mm)	G.W.(kg)
3000 pcs	7 inch	45,000 pcs	203×203×195	180,000 pcs	438×438×220	