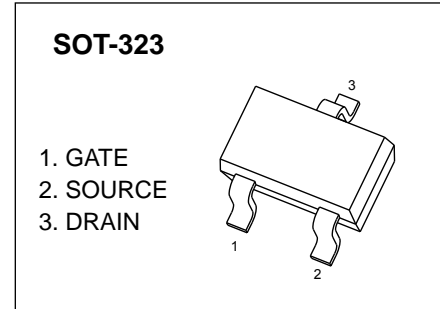

**SOT-323 Plastic-Encapsulate MOSFETS****CJ2101** P-Channel MOSFET

$V_{(BR)DSS}$	$R_{DS(on)MAX}$	I_D
-20V	100 m Ω @ -4.5V	-1.4A
	140m Ω @ -2.5V	
	210 m Ω @ -1.8V	

**FEATURE**

- Leading Trench Technology for Low $R_{DS(on)}$
Extending Battery Life

APPLICATION

- High Side Load Switch
- Charging Circuit
- Single Cell Battery Applications such as Cell Phones, Digital Cameras ,PDAs, etc

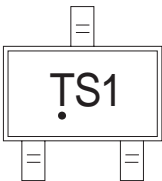
MARKING

TS1= Device code

Solid dot = Green molding compound device.

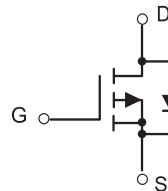
Equivalent Circuit**Maximum ratings ($T_a=25^\circ\text{C}$ unless otherwise noted)**

Parameter	Symbol	Value	Unit
Drain-Source Voltage	V_{DS}	- 20	V
Gate-Source Voltage	V_{GS}	± 8.0	
Continuous Drain Current	I_D	-1.4	A
Pulsed Drain Current ($t_p=10\mu\text{s}$)	I_{DM}	-3.0	
Power Dissipation	P_D	0.29	W
Thermal Resistance from Junction to Ambient	$R_{\theta JA}$	431	$^\circ\text{C/W}$
Operation Junction and Storage Temperature Range	T_J, T_{stg}	-55 ~+150	$^\circ\text{C}$

MOSFET ELECTRICAL CHARACTERISTICS

$T_a=25\text{ }^\circ\text{C}$ unless otherwise specified

Parameter	Symbol	Test Condition	Min	Typ	Max	Unit
OFF CHARACTERISSTICS						
Drain-Source Breakdown Voltage	V_{DSS}	$V_{GS} = 0V, I_D = -250\mu A$	-20			V
Gate-Source Leakage	I_{GSS}	$V_{DS} = 0V, V_{GS} = \pm 8V$			± 100	nA
Zero Gate Voltage Drain Current	I_{DSS}	$V_{DS} = -20V, V_{GS} = 0V$			-1.0	μA
OFF CHARACTERISSTICS (note 1)						
Gate-Source Threshold Voltage	$V_{GS(th)}$	$V_{DS} = V_{GS}, I_D = -250\mu A$	-0.45	-0.7		V
Drain-Source On-State Resistance	$R_{DS(on)}$	$V_{GS} = -4.5V, I_D = -1.0A$		82	100	m Ω
		$V_{GS} = -2.5V, I_D = -0.5A$		102	140	
		$V_{GS} = -1.8V, I_D = -0.3A$		143	210	
CHARGES AND CAPACITANCES (note 3)						
Input Capacitance	C_{iss}	$V_{DS} = -8.0V, V_{GS} = 0V, f = 1MHz$		640		pF
Output Capacitance	C_{oss}			120		
Reverse Transfer Capacitance	C_{rss}			82		
SWITCHING CHARACTERISSTICS (note 2,3)						
Turn-On Delay Time	$t_{d(on)}$	$V_{GS} = -4.5V, V_{DD} = -4.0V,$ $I_D = -1.0A, R_G = 6.2\Omega$		6.2		ns
Rise Time	t_r			15		
Turn-Off Delay Time	$t_{d(off)}$			26		
Fall Time	t_f			18		
Total Gate Charge	Q_g	$V_{DS} = -10V, V_{GS} = -4.5V, I_D = -3.0A$		5.5	10	nC
				3.3	6	
Gate-Source Charge	Q_{gs}	$V_{DS} = -10V, V_{GS} = -2.5V, I_D = -3.0A$		0.7		
Gate-Drain Charge	Q_{gd}			1.3		
Drain-source Body diode characteristics						
Forward Diode Voltage	V_{SD}	$V_{GS} = 0V, I_S = -0.3A$		-0.62	-1.2	V

Notes :

1. Pulse Test : pulse width $\leq 300\mu s$, duty cycle $\leq 2\%$.
2. Switching characteristics are independent of operating junction temperatures.
3. These parameters have no way to verify.

Typical Characteristics

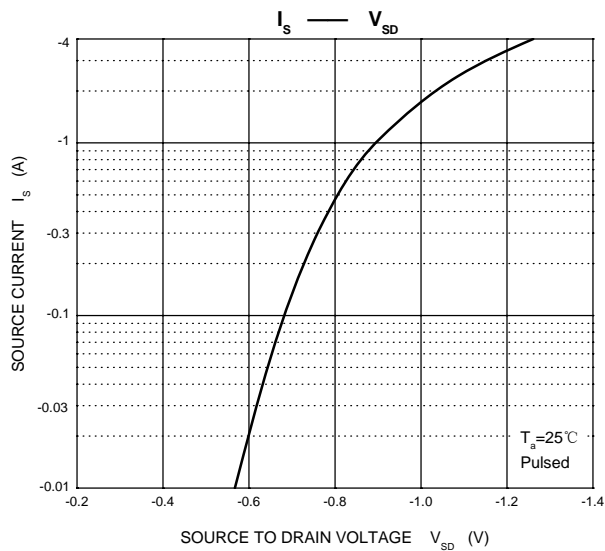
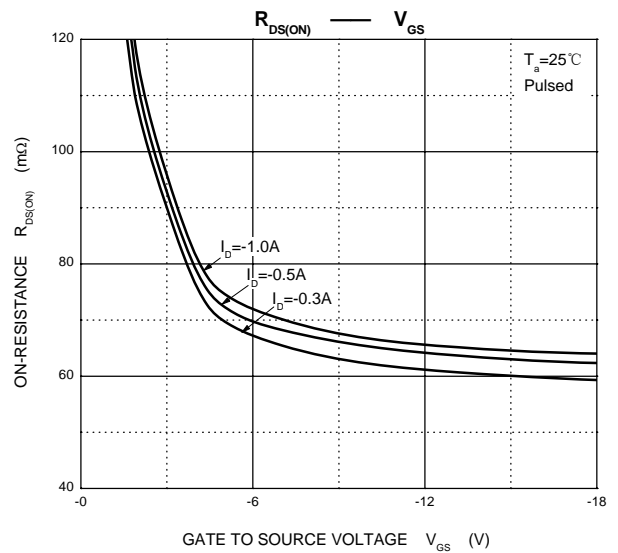
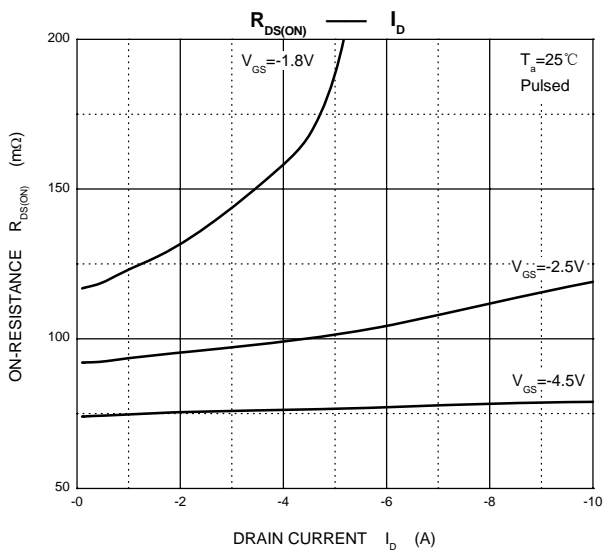
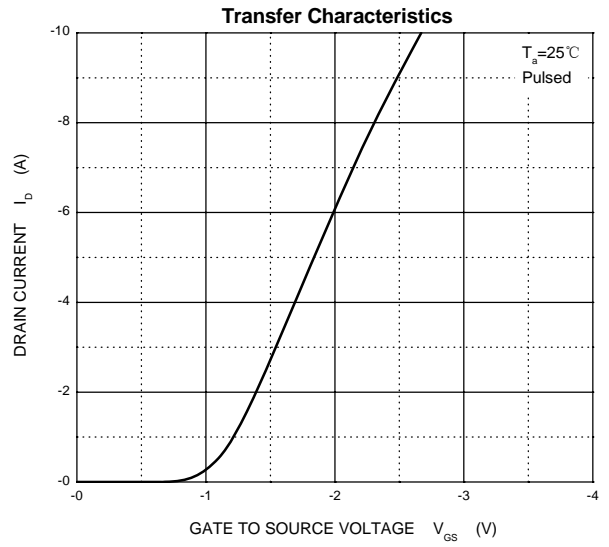
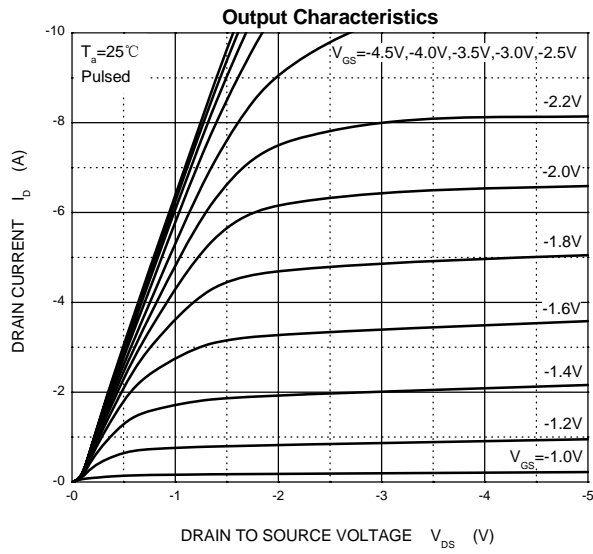

SOT-323 Package Outline Dimensions

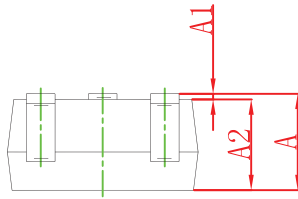
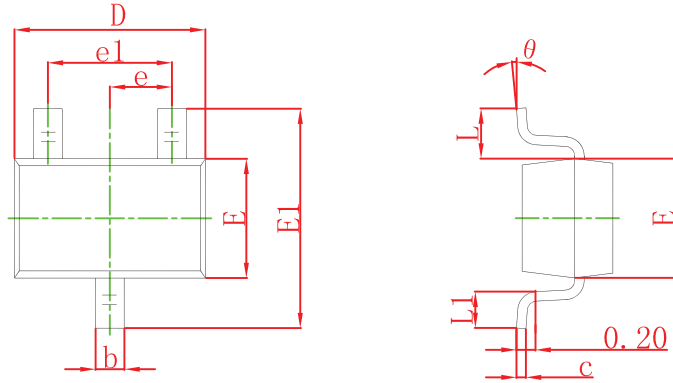

Symbol	Dimensions In Millimeters		Dimensions In Inches	
	Min	Max	Min	Max
A	0.900	1.100	0.035	0.043
A1	0.000	0.100	0.000	0.004
A2	0.900	1.000	0.035	0.039
b	0.200	0.400	0.008	0.016
c	0.080	0.150	0.003	0.006
D	2.000	2.200	0.079	0.087
E	1.150	1.350	0.045	0.053
E1	2.150	2.450	0.085	0.096
e	0.650 TYP		0.026 TYP	
e1	1.200	1.400	0.047	0.055
L	0.525 REF		0.021 REF	
L1	0.260	0.460	0.010	0.018
θ	0°	8°	0°	8°

SOT-323 Suggested Pad Layout

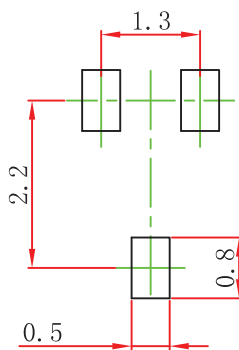

Note:

1. Controlling dimension: in millimeters.
2. General tolerance: ± 0.05 mm.
3. The pad layout is for reference purposes only.

NOTICE

JSCJ reserves the right to make modifications, enhancements, improvements, corrections or other changes without further notice to any product herein. JSCJ does not assume any liability arising out of the application or use of any product described herein.

SOT-323 Tape and Reel

SOT-323 Embossed Carrier Tape

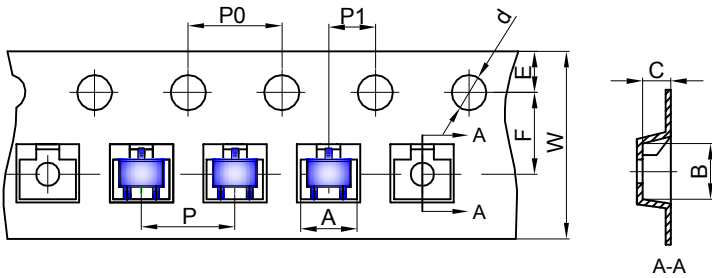

Packaging Description:
 SOT-323 parts are shipped in tape. The carrier tape is made from a dissipative (carbon filled) polycarbonate resin. The cover tape is a multilayer film (Heat Activated Adhesive in nature) primarily composed of polyester film, adhesive layer, sealant, and anti-static sprayed agent. These reeled parts in standard option are shipped with 3,000 units per 7" or 17.8cm diameter reel. The reels are clear in color and is made of polystyrene plastic (anti-static coated).

Dimensions are in millimeter										
Pkg type	A	B	C	d	E	F	P0	P	P1	W
SOT-323	2.25	2.55	1.19	Ø1.55	1.75	3.50	4.00	4.00	2.00	8.00

SOT-323 Tape Leader and Trailer

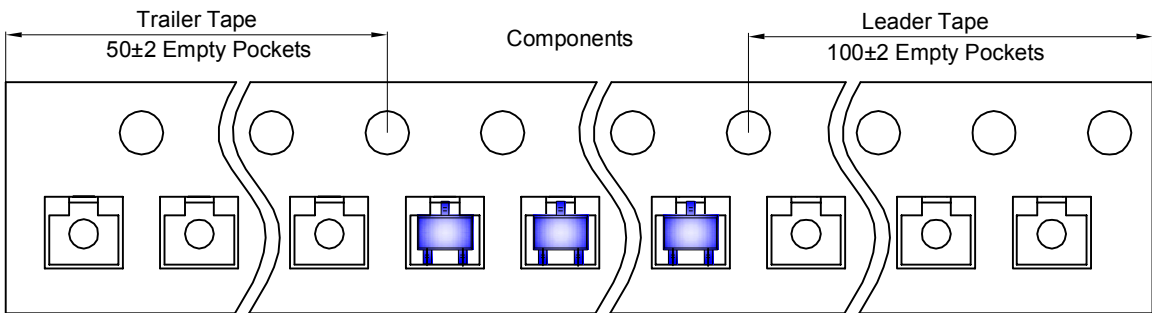

SOT-323 Reel

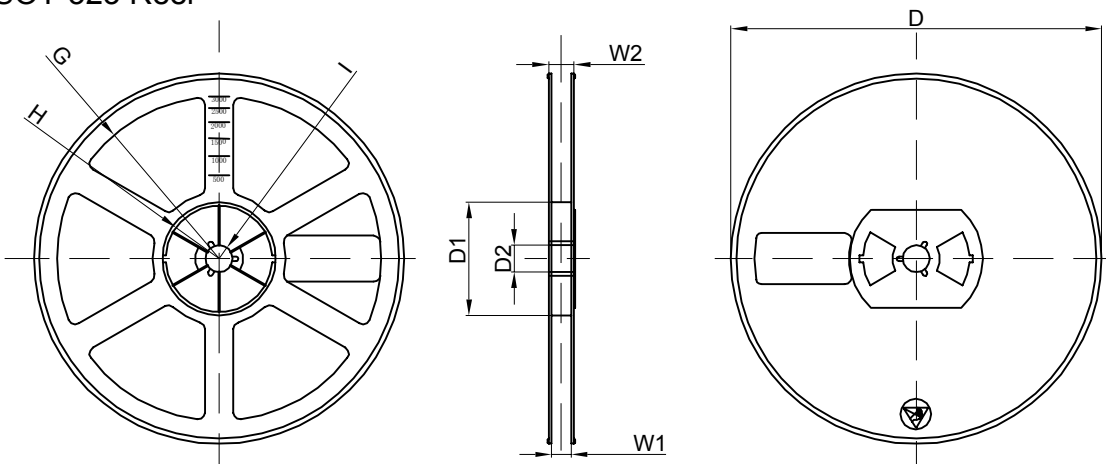

Dimensions are in millimeter								
Reel Option	D	D1	D2	G	H	I	W1	W2
7" Dia	Ø178.00	54.40	13.00	R78.00	R25.60	R6.50	9.50	12.30

REEL	Reel Size	Box	Box Size(mm)	Carton	Carton Size(mm)	G.W.(kg)
3000 pcs	7 inch	30,000 pcs	203×203×195	120,000 pcs	438×438×220	